



JCS5N50C

主要参数 MAIN CHARACTERISTICS

I_D	5 A
V_{DSS}	500 V
$R_{dson} (V_{gs}=10V)$	1.45 Ω
Q_g	14nC

用途

- 高频开关电源
- 电子镇流器
- UPS 电源

产品特性

- 低栅极电荷
- 低 C_{rss} (典型值 14pF)
- 开关速度快
- 产品全部经过雪崩测试
- 高抗 dv/dt 能力
- RoHS 产品

APPLICATIONS

- High frequency switching mode power supply
- Electronic ballast
- UPS

FEATURES

- Low gate charge
- Low C_{rss} (typical 14pF)
- Fast switching
- 100% avalanche tested
- Improved dv/dt capability
- RoHS product

封装 Package

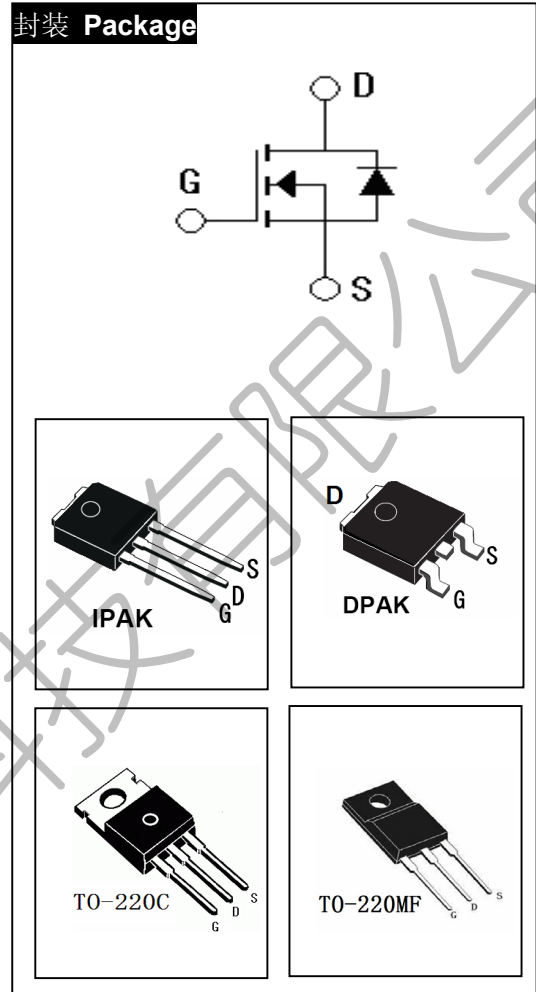

订货信息 ORDER MESSAGE

订货型号 Order codes	印记 Marking	封装 Package	无卤素 Halogen Free	包装 Packaging	器件重量 Device Weight
JCS5N50VC-O-V-N-B	JCS5N50VC	IPAK	否 NO	条管 Tube	0.35 g(typ)
JCS5N50RC-O-R-N-B	JCS5N50RC	DPAK	否 NO	条管 Tube	0.30g(typ)
JCS5N50RC-O-R-N-A	JCS5N50RC	DPAK	否 NO	编带 Brede	0.30g(typ)
JCS5N50CC-O-C-N-B	JCS5N50CC	TO-220C	否 NO	条管 Tube	2.15 g(typ)
JCS5N50FC-O-F-N-B	JCS5N50FC	TO-220MF	否 NO	条管 Tube	2.20 g(typ)





绝对最大额定值 ABSOLUTE RATINGS (Tc=25℃)

项 目 Parameter	符 号 Symbol	数 值 Value			单 位 Unit
		JCS5N50VC/RC	JCS5N50CC	JCS5N50FC	
最高漏极-源极直流电压 Drain-Source Voltage	V _{DSS}	500		500	V
连续漏极电流 Drain Current -continuous	I _D T=25℃ T=100℃	5		5*	A
		3.16		3.16*	A
最大脉冲漏极电流 (注 1) Drain Current - pulse (note 1)	I _{DM}	20		20*	A
最高栅源电压 Gate-Source Voltage	V _{GSS}	±30			V
单脉冲雪崩能量 (注 2) Single Pulsed Avalanche Energy (note 2)	E _{AS}	305			mJ
雪崩电流 (注 1) Avalanche Current (note 1)	I _{AR}	5			A
重复雪崩能量 (注 1) Repetitive Avalanche Energy (note 1)	E _{AR}	10.1			mJ
二极管反向恢复最大电压变化 速率 (注 3) Peak Diode Recovery dv/dt (note 3)	dv/dt	4.5			V/ns
耗散功率 Power Dissipation	P _D T _C =25℃ -Derate above 25℃	91	101	41	W
		0.73	0.81	0.33	W/℃
最高结温及存储温度 Operating and Storage Temperature Range	T _J , T _{STG}	-55~+150			℃
引线最高焊接温度 Maximum Lead Temperature for Soldering Purposes	T _L	300			℃

*漏极电流由最高结温限制

*Drain current limited by maximum junction temperature





电特性 ELECTRICAL CHARACTERISTICS

项 目 Parameter	符 号 Symbol	测试条件 Tests conditions	最小 Min	典型 Typ	最大 Max	单 位 Units
关态特性 Off –Characteristics						
漏—源击穿电压 Drain-Source Voltage	BV_{DSS}	$I_D=250\mu A, V_{GS}=0V$	500	-	-	V
击穿电压温度特性 Breakdown Voltage Temperature Coefficient	$\Delta BV_{DSS}/\Delta T_J$	$I_D=250\mu A$, referenced to $25^\circ C$	-	0.5	-	V/ $^\circ C$
零栅压下漏极漏电流 Zero Gate Voltage Drain Current	I_{DSS}	$V_{DS}=500V, V_{GS}=0V,$ $T_C=25^\circ C$	-	-	10	μA
		$V_{DS}=400V, T_C=125^\circ C$	-	-	100	μA
正向栅极体漏电流 Gate-body leakage current, forward	I_{GSSF}	$V_{DS}=0V, V_{GS}=30V$	-	-	100	nA
反向栅极体漏电流 Gate-body leakage current, reverse	I_{GSSR}	$V_{DS}=0V, V_{GS}=-30V$	-	-	-100	nA
通态特性 On-Characteristics						
阈值电压 Gate Threshold Voltage	$V_{GS(th)}$	$V_{DS}=V_{GS}, I_D=250\mu A$	2.0	-	4.0	V
静态导通电阻 Static Drain-Source On-Resistance	$R_{DS(ON)}$	$V_{GS}=10V, I_D=2.5A$	-	1.15	1.45	Ω
正向跨导 Forward Transconductance	g_{fs}	$V_{DS}=40V, I_D=2.5A$ (note 4)	-	5.5	-	S
动态特性 Dynamic Characteristics						
输入电容 Input capacitance	C_{iss}	$V_{DS}=25V,$ $V_{GS}=0V,$ $f=1.0MHz$	-	473	613	pF
输出电容 Output capacitance	C_{oss}		-	53	102	pF
反向传输电容 Reverse transfer capacitance	C_{rss}		-	14	19	pF





电特性 ELECTRICAL CHARACTERISTICS

开关特性 Switching Characteristics						
延迟时间 Turn-On delay time	$t_d(\text{on})$	$V_{DD}=250V, I_D=5A, R_G=25\Omega$ (note 4, 5)	-	45	60	ns
上升时间 Turn-On rise time	t_r		-	26	34	ns
延迟时间 Turn-Off delay time	$t_d(\text{off})$		-	133	170	ns
下降时间 Turn-Off Fall time	t_f		-	214	270	ns
栅极电荷总量 Total Gate Charge	Q_g	$V_{DS}=400V,$ $I_D=5A$ $V_{GS}=10V$ (note 4, 5)	-	14	20	nC
栅-源电荷 Gate-Source charge	Q_{gs}		-	3.5	-	nC
栅-漏电荷 Gate-Drain charge	Q_{gd}		-	6	-	nC
漏-源二极管特性及最大额定值 Drain-Source Diode Characteristics and Maximum Ratings						
正向最大连续电流 Maximum Continuous Drain -Source Diode Forward Current		I_S	-	-	5	A
正向最大脉冲电流 Maximum Pulsed Drain-Source Diode Forward Current		I_{SM}	-	-	20	A
正向压降 Drain-Source Diode Forward Voltage	V_{SD}	$V_{GS}=0V,$ $I_S=5A$	-	-	1.4	V
反向恢复时间 Reverse recovery time	t_{rr}	$V_{GS}=0V, I_S=5A$ $di/dt=100A/\mu s$ (note 4)	-	268	-	ns
反向恢复电荷 Reverse recovery charge	Q_{rr}		-	2.1	-	μC

热特性 THERMAL CHARACTERISTIC

项 目 Parameter	符 号 Symbol	最大 Max			单 位 Unit
		JCS5N50VC/RC	JCS5N50CC	JCS5N50FC	
结到管壳的热阻 Thermal Resistance, Junction to Case	$R_{th(j-c)}$	1.38	1.23	3.08	$^{\circ}C/W$
结到环境的热阻 Thermal Resistance, Junction to Ambient	$R_{th(j-A)}$	110	62.5	62.5	$^{\circ}C/W$

注释:

- 1: 脉冲宽度由最高结温限制
- 2: $L=10.5mH, I_{AS}=5A, V_{DD}=50V, R_G=25\Omega$, 起始结温 $T_J=25^{\circ}C$
- 3: $I_{SD}\leq 5A, di/dt\leq 200A/\mu s, V_{DD}\leq BV_{DSS}$, 起始结温 $T_J=25^{\circ}C$
- 4: 脉冲测试: 脉冲宽度 $\leq 300\mu s$, 占空比 $\leq 2\%$
- 5: 基本与工作温度无关

Notes:

- 1: Pulse width limited by maximum junction temperature
- 2: $L=10.5mH, I_{AS}=5A, V_{DD}=50V, R_G=25\Omega$, Starting $T_J=25^{\circ}C$
- 3: $I_{SD}\leq 5A, di/dt\leq 200A/\mu s, V_{DD}\leq BV_{DSS}$, Starting $T_J=25^{\circ}C$
- 4: Pulse Test: Pulse Width $\leq 300\mu s$, Duty Cycle $\leq 2\%$
- 5: Essentially independent of operating temperature





特征曲线 ELECTRICAL CHARACTERISTICS (curves)

On-Region Characteristics

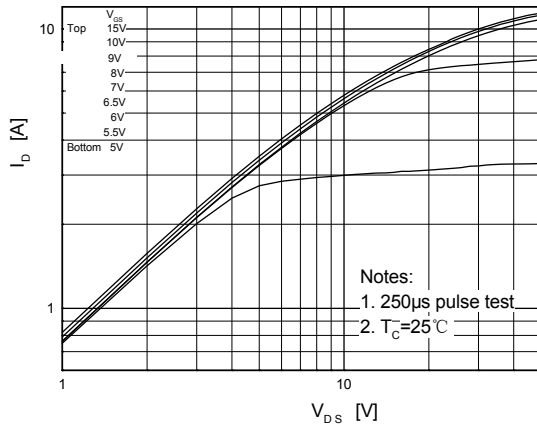

Transfer Characteristics

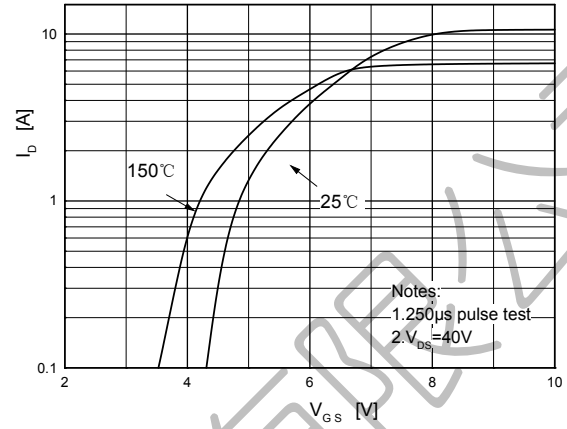

On-Resistance Variation vs. Drain Current and Gate Voltage

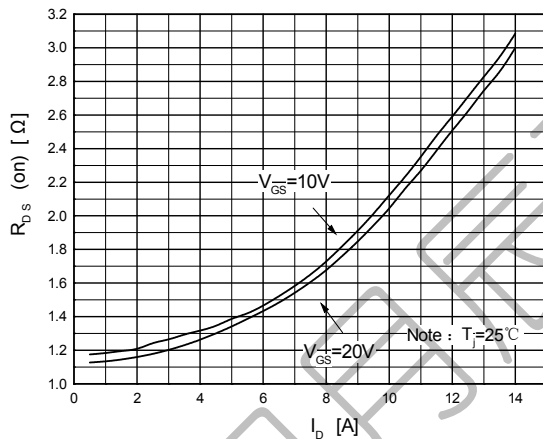

Body Diode Forward Voltage Variation vs. Source Current and Temperature

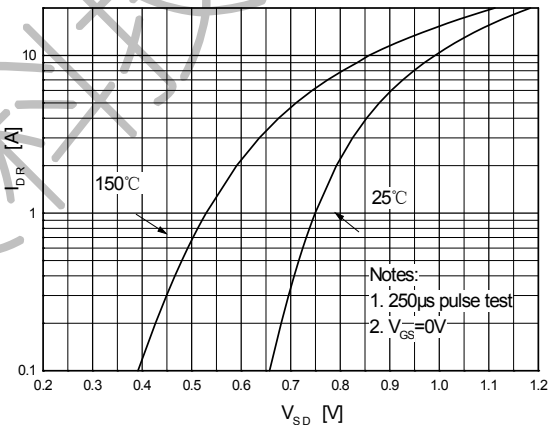

Capacitance Characteristics

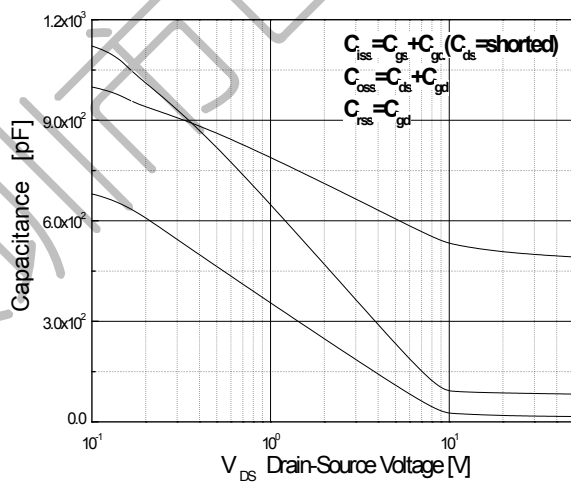

Gate Charge Characteristics

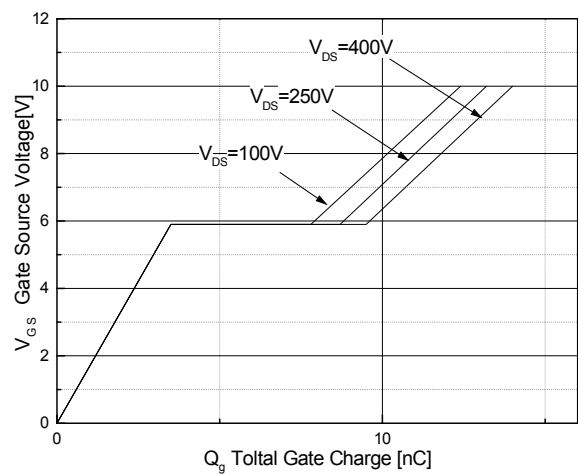



特征曲线 ELECTRICAL CHARACTERISTICS (curves)

Breakdown Voltage Variation vs. Temperature

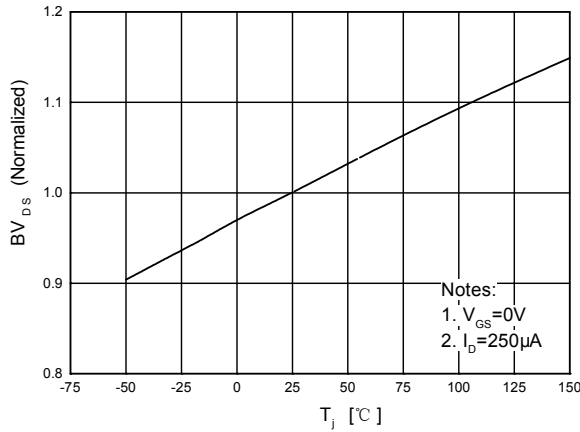

On-Resistance Variation vs. Temperature

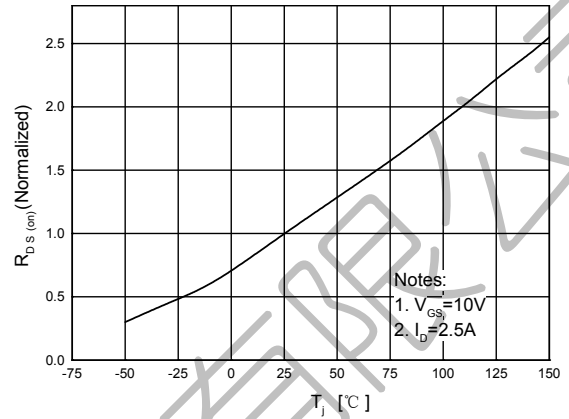

Maximum Safe Operating Area For JCS5N50VC/RC/CC

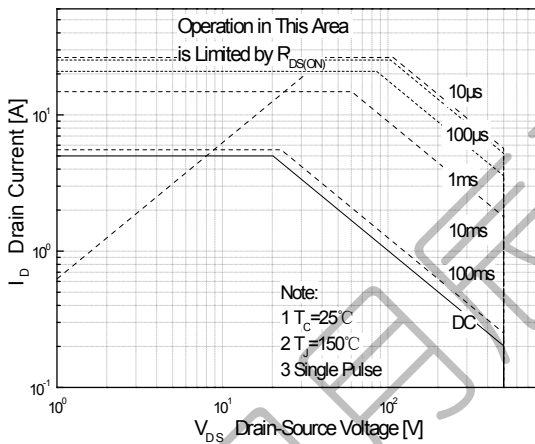

Maximum Safe Operating Area For JCS5N50FC

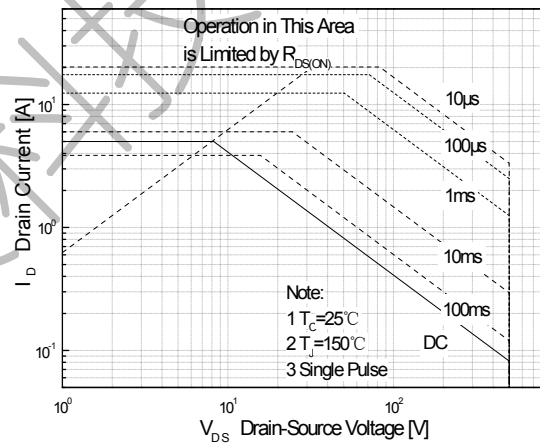

Maximum Drain Current vs. Case Temperature

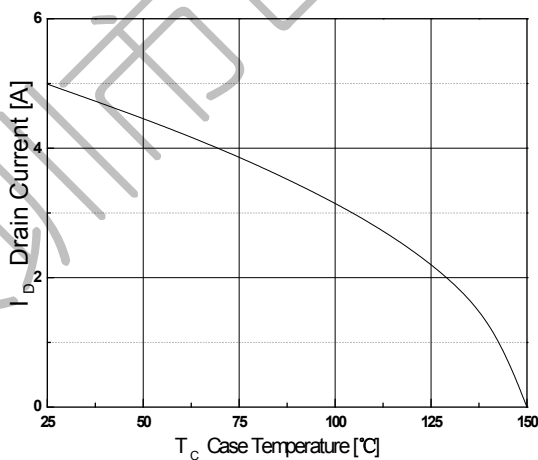



特征曲线 ELECTRICAL CHARACTERISTICS (curves)

Transient Thermal Response Curve For JCS5N50VC/RC

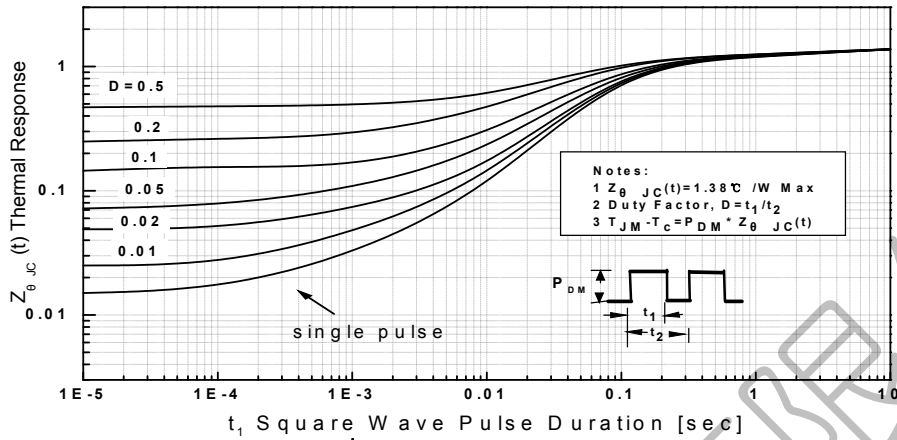

Transient Thermal Response Curve For JCS5N50CC

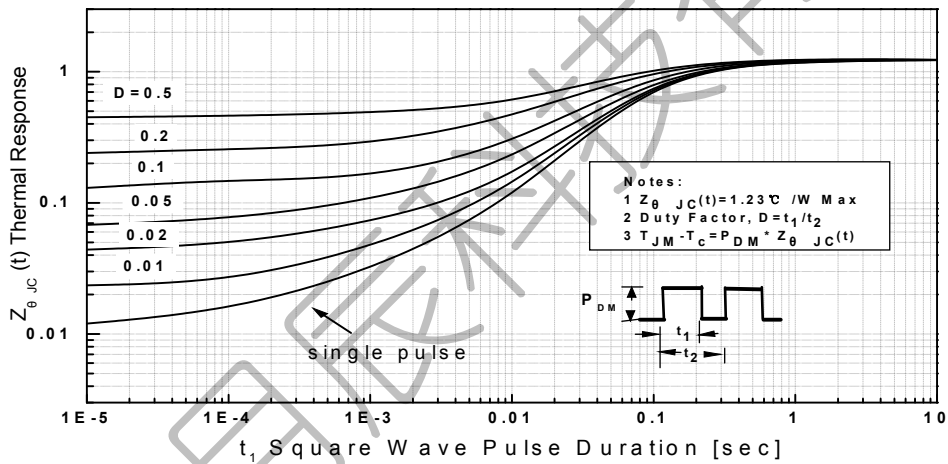

Transient Thermal Response Curve For JCS5N50FC

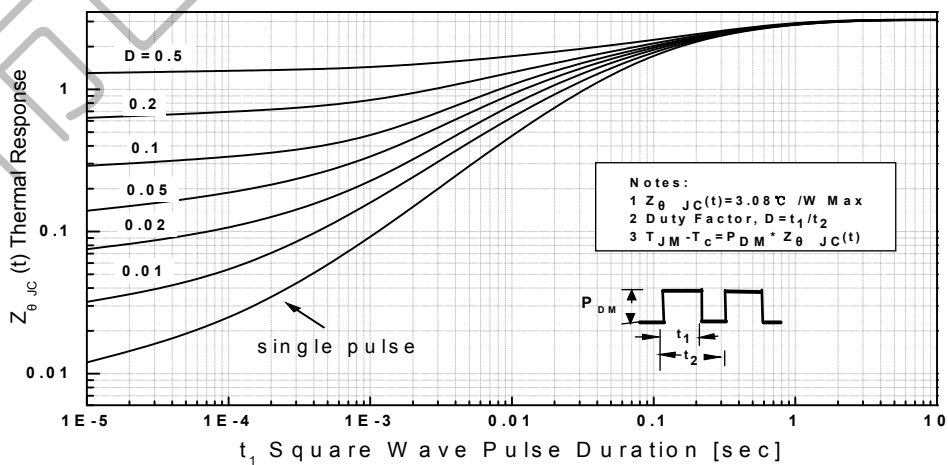



I_{PAK}

单位 Unit: mm

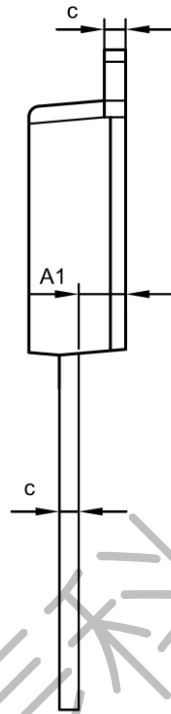
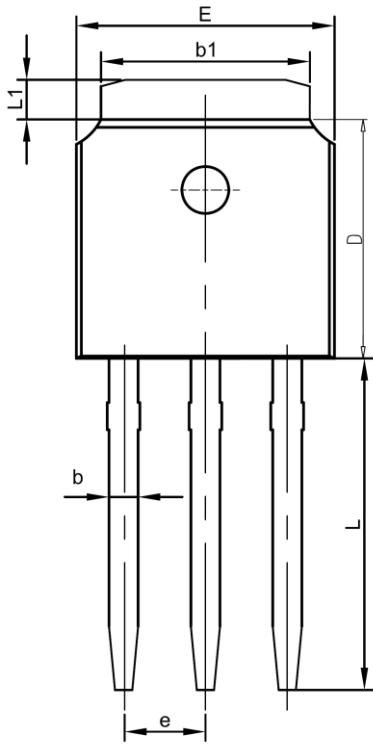

SYMBOL	MM	
	MIN	MAX
A	2.1	2.5
A1	0.87	1.27
b	0.63	0.93
b1	5.13	5.53
c	0.40	0.60
D	5.80	6.40
E	6.30	6.90
L	9.10	9.70
e	2.286BSC	
L1	0.82	1.22

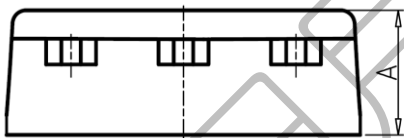



DPAK

单位 Unit: mm

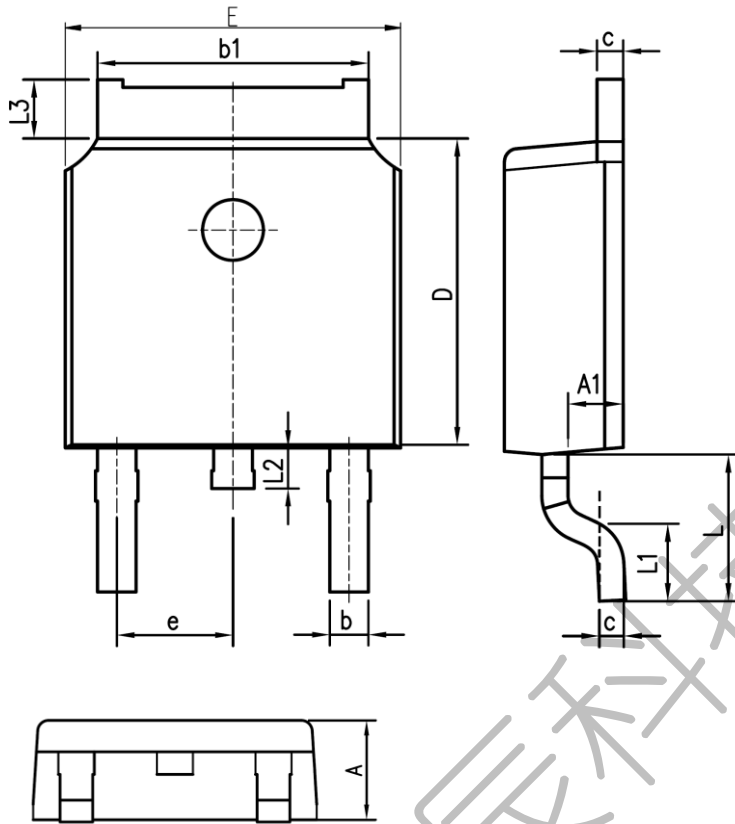

SYMBOL	mm	
	MIN	MAX
A	2.10	2.50
A1	0.97	1.17
b	0.63	0.93
b1	5.13	5.53
c	0.40	0.60
D	5.80	6.40
E	6.30	6.90
e	2.286BSC	
L	2.50	3.30
L1	1.20	1.80
L2	0.60	1.00
L3	0.85	1.30

编带 REEL

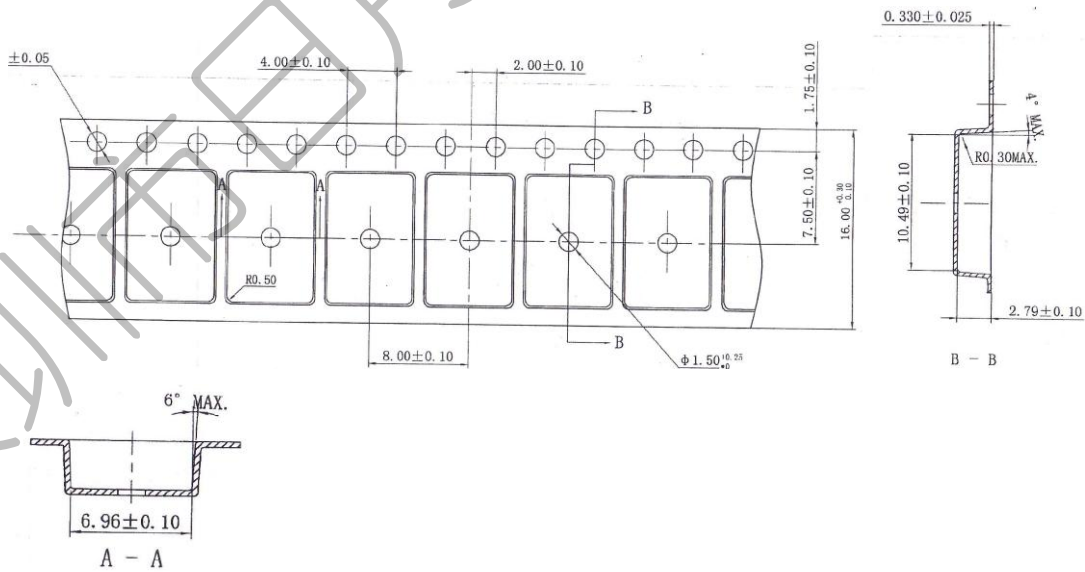



外形尺寸 PACKAGE MECHANICAL DATA

TO-220C

单位 Unit: mm

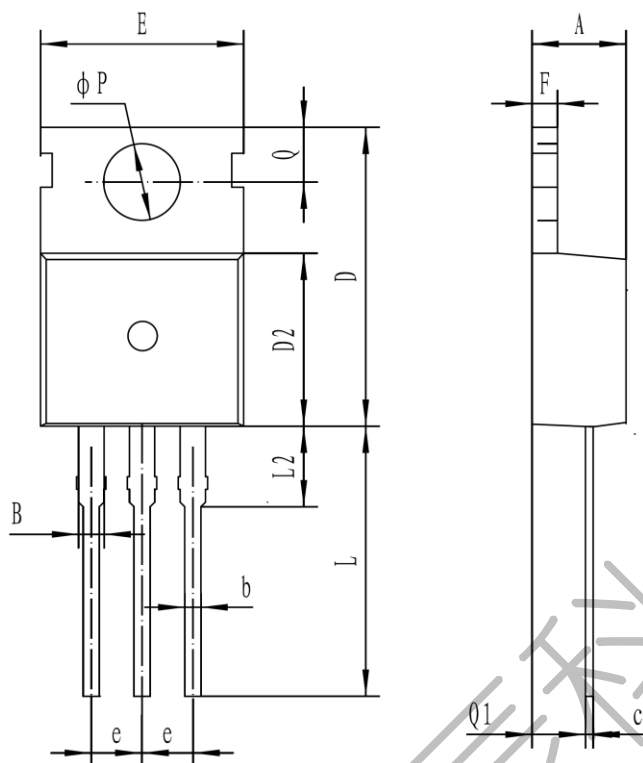

符号 symbol	MIN	MAX
A	4.30	4.70
B	1.22	1.47
b	0.70	0.95
c	0.40	0.65
D	15.20	16.20
D2	9.00	9.40
E	9.70	10.10
e	2.39	2.69
F	1.25	1.40
L	12.60	13.60
L2	2.80	3.20
Q	2.60	3.00
Q1	2.20	2.60
P	3.50	3.80





外形尺寸 PACKAGE MECHANICAL DATA

TO-220MF

单位 Unit: mm

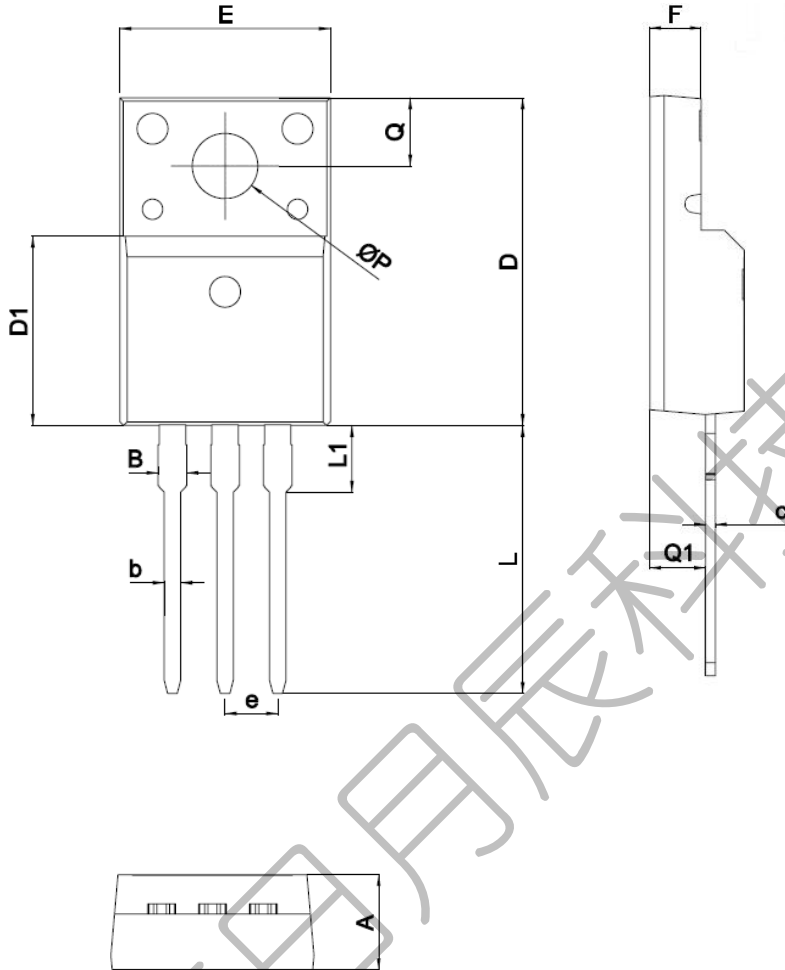

SYMBOL	mm	
	MIN	MAX
A	4.5	4.9
B		1.47
b	0.7	0.9
e	0.45	0.60
D	15.67	16.07
D1	9.04	9.20
e	2.54TYPE	
E	9.96	10.36
F	2.34	2.74
L	12.58	13.38
L1	3.13	3.33
Q	3.2	3.4
Q1	2.56	2.96
ΦP	3.08	3.28





联系方式

深圳市日月辰科技有限公司

公司地址：深圳市宝安区松岗街道潭头第二工业城A27栋

邮编：518000

总机：86-755-29556626

手机：86-13113000010

网址：www.szryc.com

CONTACT

SHENZHEN CITY RIYUECHE TECH CO., LTD.

ADD: Songgang shenzhen City, Guangdong Province, China.

Post Code: 518000

Tel: 86-755-29556626

Fax: 86-13113000010

Web Site: www.szryc.com

