

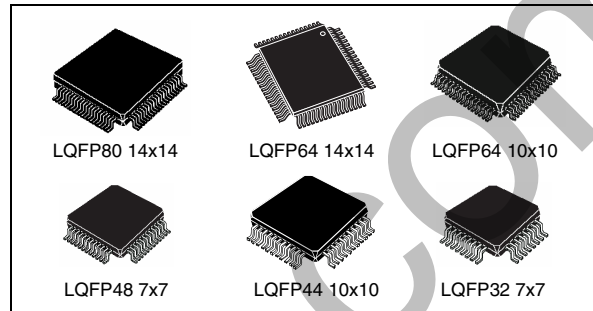


STM8S207xx STM8S208xx

Performance line, 24 MHz STM8S 8-bit MCU, up to 128 Kbytes Flash, integrated EEPROM, 10-bit ADC, timers, 2 UARTs, SPI, I²C, CAN

Features

- Core
 - Max f_{CPU} : up to 24 MHz, 0 wait states @ $f_{CPU} \leq 16$ MHz
 - Advanced STM8 core with Harvard architecture and 3-stage pipeline
 - Extended instruction set
 - Max 20 MIPS @ 24 MHz
- Memories
 - Program: up to 128 Kbytes Flash; data retention 20 years at 55 °C after 10 kcycles
 - Data: up to 2 Kbytes true data EEPROM; endurance 300 kcycles
 - RAM: up to 6 Kbytes
- Clock, reset and supply management
 - 2.95 to 5.5 V operating voltage
 - Flexible clock control:
 - Low power crystal resonator oscillator
 - External clock input
 - Internal, user-trimmable 16 MHz RC
 - Internal low power 128 kHz RC
 - Clock security system with clock monitor
 - Power management:
 - Wait, active-halt, & halt low power modes
 - Peripheral clocks switched off individually
 - Permanently active, low consumption power-on and power-down reset
- Interrupt management
 - Nested interrupt controller with 32 interrupts
 - Up to 37 external interrupts on 6 vectors
- Timers
 - 2x 16-bit general purpose timers, with 2+3 CAPCOM channels (IC, OC or PWM)
 - Advanced control timer: 16-bit, 4 CAPCOM channels, 3 complementary outputs, dead-time insertion and flexible synchronization
 - 8-bit basic timer with 8-bit prescaler
 - Auto wakeup timer
 - Window watchdog, independent watchdog



- Communications interfaces
 - High speed 1 Mbit/s active beCAN 2.0B
 - UART with clock output for synchronous operation - LIN master mode
 - UART with LIN 2.1 compliant, master/slave modes and automatic resynchronization
 - SPI interface up to 10 Mbit/s
 - I²C interface up to 400 Kbit/s
- 10-bit ADC with up to 16 channels
- I/Os
 - Up to 68 I/Os on an 80-pin package including 18 high sink outputs
 - Highly robust I/O design, immune against current injection
 - Development support
 - Single wire interface module (SWIM) and debug module (DM)
- Unique ID
 - 96-bit unique key for each device

Table 1. Device summary

Part numbers: STM8S207xx
STM8S207MB, STM8S207M8, STM8S207RB, STM8S207R8, STM8S207R6, STM8S207CB, STM8S207C8, STM8S207C6, STM8S207SB, STM8S207S8, STM8S207S6, STM8S207K6
Part numbers: STM8S208xx
STM8S208MB, STM8S208RB, STM8S208R8, STM8S208R6, STM8S208CB, STM8S208C8, STM8S208C6, STM8S208SB, STM8S208S8, STM8S208S6

Contents

1	Introduction	9
2	Description	10
3	Block diagram	12
4	Product overview	13
4.1	Central processing unit STM8	13
4.2	Single wire interface module (SWIM) and debug module (DM)	14
4.3	Interrupt controller	14
4.4	Flash program and data EEPROM memory	15
4.5	Clock controller	16
4.6	Power management	17
4.7	Watchdog timers	17
4.8	Auto wakeup counter	18
4.9	Beeper	18
4.10	TIM1 - 16-bit advanced control timer	18
4.11	TIM2, TIM3 - 16-bit general purpose timers	18
4.12	TIM4 - 8-bit basic timer	19
4.13	Analog-to-digital converter (ADC2)	19
4.14	Communication interfaces	19
4.14.1	UART1	20
4.14.2	UART3	20
4.14.3	SPI	21
4.14.4	I ² C	22
4.14.5	beCAN	22
5	Pinouts and pin description	23
5.1	Package pinouts	23
5.2	Alternate function remapping	32
6	Memory and register map	33
6.1	Memory map	33

6.2	Register map	34
7	Interrupt vector mapping	46
8	Option bytes	47
9	Unique ID	51
10	Electrical characteristics	52
10.1	Parameter conditions	52
10.1.1	Minimum and maximum values	52
10.1.2	Typical values	52
10.1.3	Typical curves	52
10.1.4	Typical current consumption	52
10.1.5	Pin loading conditions	53
10.1.6	Loading capacitor	53
10.1.7	Pin input voltage	53
10.2	Absolute maximum ratings	54
10.3	Operating conditions	56
10.3.1	VCAP external capacitor	57
10.3.2	Supply current characteristics	58
10.3.3	External clock sources and timing characteristics	65
10.3.4	Internal clock sources and timing characteristics	67
10.3.5	Memory characteristics	69
10.3.6	I/O port pin characteristics	70
10.3.7	Reset pin characteristics	76
10.3.8	SPI serial peripheral interface	78
10.3.9	I ² C interface characteristics	81
10.3.10	10-bit ADC characteristics	83
10.3.11	EMC characteristics	86
11	Package characteristics	89
11.1	Package mechanical data	90
11.1.1	LQFP package mechanical data	90
11.2	Thermal characteristics	96
11.2.1	Reference document	96
11.2.2	Selecting the product temperature range	97

12 STM8 development tools 98

- 12.1 Emulation and in-circuit debugging tools 98
- 12.2 Software tools 99
 - 12.2.1 STM8 toolset 99
 - 12.2.2 C and assembly toolchains 99
- 12.3 Programming tools 99

13 Ordering information 100

14 Revision history 101

WWW.SZRYC.COM



List of tables

Table 1.	Device summary	1
Table 2.	STM8S20xxx performance line features.	11
Table 3.	Peripheral clock gating bit assignments in CLK_PCKENR1/2 registers.	16
Table 4.	TIM timer features.	19
Table 5.	Legend/abbreviations	27
Table 6.	Pin description	28
Table 7.	Flash, Data EEPROM and RAM boundary addresses	34
Table 8.	I/O port hardware register map	34
Table 9.	General hardware register map	36
Table 10.	CPU/SWIM/debug module/interrupt controller registers.	44
Table 11.	Interrupt mapping	46
Table 12.	Option bytes	47
Table 13.	Option byte description	48
Table 14.	Unique ID registers (96 bits)	51
Table 15.	Voltage characteristics	54
Table 16.	Current characteristics	55
Table 17.	Thermal characteristics.	55
Table 18.	General operating conditions	56
Table 19.	Operating conditions at power-up/power-down	57
Table 20.	Total current consumption with code execution in run mode at $V_{DD} = 5\text{ V}$	58
Table 21.	Total current consumption with code execution in run mode at $V_{DD} = 3.3\text{ V}$	59
Table 22.	Total current consumption in wait mode at $V_{DD} = 5\text{ V}$	60
Table 23.	Total current consumption in wait mode at $V_{DD} = 3.3\text{ V}$	60
Table 24.	Total current consumption in active halt mode at $V_{DD} = 5\text{ V}$, $T_A -40\text{ to }85^\circ\text{ C}$	61
Table 25.	Total current consumption in active halt mode at $V_{DD} = 3.3\text{ V}$	61
Table 26.	Total current consumption in halt mode at $V_{DD} = 5\text{ V}$, $T_A -40\text{ to }85^\circ\text{ C}$	62
Table 27.	Total current consumption in halt mode at $V_{DD} = 3.3\text{ V}$	62
Table 28.	Wakeup times	62
Table 29.	Total current consumption and timing in forced reset state	63
Table 30.	Peripheral current consumption	63
Table 31.	HSE user external clock characteristics	65
Table 32.	HSE oscillator characteristics	66
Table 33.	HSI oscillator characteristics.	67
Table 34.	LSI oscillator characteristics	68
Table 35.	RAM and hardware registers	69
Table 36.	Flash program memory/data EEPROM memory	69
Table 37.	I/O static characteristics	70
Table 38.	Output driving current (standard ports).	72
Table 39.	Output driving current (true open drain ports).	72
Table 40.	Output driving current (high sink ports).	72
Table 41.	NRST pin characteristics	76
Table 42.	SPI characteristics	78
Table 43.	I ² C characteristics.	81
Table 44.	ADC characteristics	83
Table 45.	ADC accuracy with $R_{AIN} < 10\text{ k}\Omega$, $V_{DDA} = 5\text{ V}$	84
Table 46.	ADC accuracy with $R_{AIN} < 10\text{ k}\Omega$, R_{AIN} , $V_{DDA} = 3.3\text{ V}$	84
Table 47.	EMS data	86
Table 48.	EMI data	87

Table 49.	ESD absolute maximum ratings	87
Table 50.	Electrical sensitivities	88
Table 51.	80-pin low profile quad flat package mechanical data	90
Table 52.	64-pin low profile quad flat package mechanical data (14 x 14)	91
Table 53.	64-pin low profile quad flat package mechanical data (10 x 10)	92
Table 54.	48-pin low profile quad flat package mechanical data	93
Table 55.	44-pin low profile quad flat package mechanical data	94
Table 56.	32-pin low profile quad flat package mechanical data	95
Table 57.	Thermal characteristics	96
Table 58.	Document revision history	101

List of figures

Figure 1.	STM8S20xxx performance line block diagram	12
Figure 2.	Flash memory organisation	15
Figure 3.	LQFP 80-pin pinout	23
Figure 4.	LQFP 64-pin pinout	24
Figure 5.	LQFP 48-pin pinout	25
Figure 6.	LQFP 44-pin pinout	26
Figure 7.	LQFP 32-pin pinout	27
Figure 8.	Memory map	33
Figure 9.	Supply current measurement conditions	52
Figure 10.	Pin loading conditions	53
Figure 11.	Pin input voltage	53
Figure 12.	f_{CPUmax} versus V_{DD}	57
Figure 13.	External capacitor C_{EXT}	57
Figure 14.	Typ. $I_{DD(RUN)}$ vs V_{DD} , HSI RC osc, $f_{CPU} = 16$ MHz	64
Figure 15.	Typ. $I_{DD(WFI)}$ vs V_{DD} , HSI RC osc, $f_{CPU} = 16$ MHz	64
Figure 16.	HSE external clock source	65
Figure 17.	HSE oscillator circuit diagram	66
Figure 18.	Typical HSI frequency variation vs V_{DD} at 4 temperatures	67
Figure 19.	Typical LSI frequency variation vs V_{DD} @ 25 °C	68
Figure 20.	Typical V_{IL} and V_{IH} vs V_{DD} @ 4 temperatures	71
Figure 21.	Typical pull-up resistance vs V_{DD} @ 4 temperatures	71
Figure 22.	Typical pull-up current vs V_{DD} @ 4 temperatures	71
Figure 23.	Typ. V_{OL} @ $V_{DD} = 5$ V (standard ports)	73
Figure 24.	Typ. V_{OL} @ $V_{DD} = 3.3$ V (standard ports)	73
Figure 25.	Typ. V_{OL} @ $V_{DD} = 5$ V (true open drain ports)	73
Figure 26.	Typ. V_{OL} @ $V_{DD} = 3.3$ V (true open drain ports)	74
Figure 27.	Typ. V_{OL} @ $V_{DD} = 5$ V (high sink ports)	74
Figure 28.	Typ. V_{OL} @ $V_{DD} = 3.3$ V (high sink ports)	74
Figure 29.	Typ. $V_{DD} - V_{OH}$ @ $V_{DD} = 5$ V (standard ports)	75
Figure 30.	Typ. $V_{DD} - V_{OH}$ @ $V_{DD} = 3.3$ V (standard ports)	75
Figure 31.	Typ. $V_{DD} - V_{OH}$ @ $V_{DD} = 5$ V (high sink ports)	75
Figure 32.	Typ. $V_{DD} - V_{OH}$ @ $V_{DD} = 3.3$ V (high sink ports)	76
Figure 33.	Typical NRST V_{IL} and V_{IH} vs V_{DD} @ 4 temperatures	76
Figure 34.	Typical NRST pull-up resistance vs V_{DD} @ 4 temperatures	77
Figure 35.	Typical NRST pull-up current I_{pu} vs V_{DD} @ 4 temperatures	77
Figure 36.	Recommended reset pin protection	77
Figure 37.	SPI timing diagram - slave mode and $CPHA = 0$	79
Figure 38.	SPI timing diagram - slave mode and $CPHA = 1^{(1)}$	79
Figure 39.	SPI timing diagram - master mode ⁽¹⁾	80
Figure 40.	Typical application with I ² C bus and timing diagram ⁽¹⁾	82
Figure 41.	ADC accuracy characteristics	85
Figure 42.	Typical application with ADC	85
Figure 43.	80-pin low profile quad flat package (14 x 14)	90
Figure 44.	64-pin low profile quad flat package (14 x 14)	91
Figure 45.	64-pin low profile quad flat package (10 x 10)	92
Figure 46.	48-pin low profile quad flat package (7 x 7)	93
Figure 47.	44-pin low profile quad flat package (10 x 10)	94
Figure 48.	32-pin low profile quad flat package (7 x 7)	95

Figure 49. STM8S207xx/208xx performance line ordering information scheme⁽¹⁾ 100

WWW.SZRYC.COM

1 Introduction

This datasheet contains the description of the STM8S20xxx performance line features, pinout, electrical characteristics, mechanical data and ordering information.

- For complete information on the STM8S microcontroller memory, registers and peripherals, please refer to the STM8S microcontroller family reference manual (RM0016).
- For information on programming, erasing and protection of the internal Flash memory please refer to the STM8S Flash programming manual (PM0051).
- For information on the debug and SWIM (single wire interface module) refer to the STM8 SWIM communication protocol and debug module user manual (UM0470).
- For information on the STM8 core, please refer to the STM8 CPU programming manual (PM0044).

2 Description

The STM8S20xxx performance line 8-bit microcontrollers offer from 32 to 128 Kbytes Flash program memory. They are referred to as high-density devices in the STM8S microcontroller family Reference Manual (RM0016).

All devices of the STM8S20xxx performance line provide the following benefits:

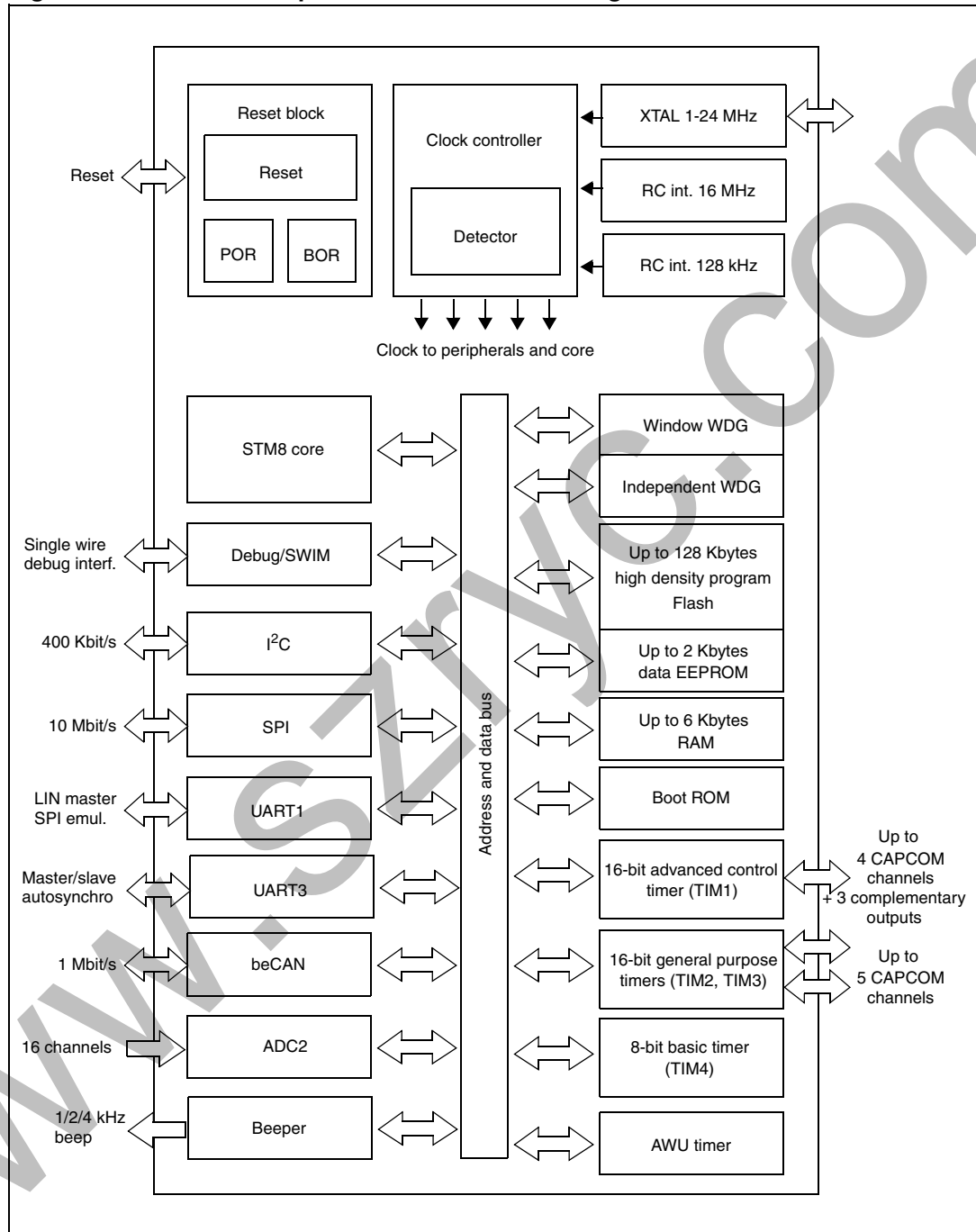
- Reduced system cost
 - Integrated true data EEPROM for up to 300 k write/erase cycles
 - High system integration level with internal clock oscillators, watchdog and brown-out reset.
- Performance and robustness
 - 20 MIPS at 24 MHz CPU clock frequency
 - Robust I/O, independent watchdogs with separate clock source
 - Clock security system
- Short development cycles
 - Applications scalability across a common family product architecture with compatible pinout, memory map and modular peripherals.
 - Full documentation and a wide choice of development tools
- Product longevity
 - Advanced core and peripherals made in a state-of-the art technology
 - A family of products for applications with 2.95 V to 5.5 V operating supply

Table 2. STM8S20xxx performance line features

Device	Pin count	Maximum number of GPIOs (I/O)	Ext. Interrupt pins	Timer CAPCOM channels	Timer complementary outputs	A/D Converter channels	High sink I/Os	High density Flash Program memory (bytes)	Data EEPROM (bytes)	RAM (bytes)	beCAN interface
STM8S207MB	80	68	37	9	3	16	18	128 K	2048	6 K	No
STM8S207M8	80	68	37	9	3	16	18	64 K	2048	6 K	
STM8S207RB	64	52	36	9	3	16	16	128 K	2048	6 K	
STM8S207R8	64	52	36	9	3	16	16	64 K	1536	4 K	
STM8S207R6	64	52	36	9	3	16	16	32 K	1024	2 K	
STM8S207CB	48	38	35	9	3	10	16	128 K	2048	6 K	
STM8S207C8	48	38	35	9	3	10	16	64 K	1536	4 K	
STM8S207C6	48	38	35	9	3	10	16	32 K	1024	2 K	
STM8S207SB	44	34	31	8	3	9	15	128 K	1536	4 K	
STM8S207S8	44	34	31	8	3	9	15	64 K	1536	4 K	
STM8S207S6	44	34	31	8	3	9	15	32 K	1024	2 K	
STM8S207K6	32	25	23	8	3	7	12	32 K	1024	2 K	
STM8S208MB	80	68	37	9	3	16	18	128 K	2048	6 K	
STM8S208RB	64	52	37	9	3	16	16	128 K	2048	6 K	
STM8S208R8	64	52	37	9	3	16	16	64 K	2048	6 K	
STM8S208R6	64	52	37	9	3	16	16	32 K	2048	6 K	
STM8S208CB	48	38	35	9	3	10	16	128 K	2048	6 K	
STM8S208C8	48	38	35	9	3	10	16	64 K	2048	6 K	
STM8S208C6	48	38	35	9	3	10	16	32 K	2048	6 K	
STM8S208SB	44	34	31	8	3	9	15	128 K	1536	4 K	
STM8S208S8	44	34	31	8	3	9	15	64 K	1536	4 K	
STM8S208S6	44	34	31	8	3	9	15	32 K	1536	4 K	

3 Block diagram

Figure 1. STM8S20xxx performance line block diagram



4 Product overview

The following section intends to give an overview of the basic features of the STM8S20xxx performance line functional modules and peripherals.

For more detailed information please refer to the corresponding family reference manual (RM0016).

4.1 Central processing unit STM8

The 8-bit STM8 core is designed for code efficiency and performance.

It contains 6 internal registers which are directly addressable in each execution context, 20 addressing modes including indexed indirect and relative addressing and 80 instructions.

Architecture and registers

- Harvard architecture
- 3-stage pipeline
- 32-bit wide program memory bus - single cycle fetching for most instructions
- X and Y 16-bit index registers - enabling indexed addressing modes with or without offset and read-modify-write type data manipulations
- 8-bit accumulator
- 24-bit program counter - 16-Mbyte linear memory space
- 16-bit stack pointer - access to a 64 K-level stack
- 8-bit condition code register - 7 condition flags for the result of the last instruction

Addressing

- 20 addressing modes
- Indexed indirect addressing mode for look-up tables located anywhere in the address space
- Stack pointer relative addressing mode for local variables and parameter passing

Instruction set

- 80 instructions with 2-byte average instruction size
- Standard data movement and logic/arithmetic functions
- 8-bit by 8-bit multiplication
- 16-bit by 8-bit and 16-bit by 16-bit division
- Bit manipulation
- Data transfer between stack and accumulator (push/pop) with direct stack access
- Data transfer using the X and Y registers or direct memory-to-memory transfers

4.2 Single wire interface module (SWIM) and debug module (DM)

The single wire interface module and debug module permits non-intrusive, real-time in-circuit debugging and fast memory programming.

SWIM

Single wire interface module for direct access to the debug module and memory programming. The interface can be activated in all device operation modes. The maximum data transmission speed is 145 bytes/ms.

Debug module

The non-intrusive debugging module features a performance close to a full-featured emulator. Beside memory and peripherals, also CPU operation can be monitored in real-time by means of shadow registers.

- R/W to RAM and peripheral registers in real-time
- R/W access to all resources by stalling the CPU
- Breakpoints on all program-memory instructions (software breakpoints)
- Two advanced breakpoints, 23 predefined configurations

4.3 Interrupt controller

- Nested interrupts with three software priority levels
- 32 interrupt vectors with hardware priority
- Up to 37 external interrupts on six vectors including TLI
- Trap and reset interrupts

4.4 Flash program and data EEPROM memory

- Up to 128 Kbytes of high density Flash program single voltage Flash memory
- Up to 2K bytes true data EEPROM
- Read while write: Writing in data memory possible while executing code in program memory.
- User option byte area

Write protection (WP)

Write protection of Flash program memory and data EEPROM is provided to avoid unintentional overwriting of memory that could result from a user software malfunction.

There are two levels of write protection. The first level is known as MASS (memory access security system). MASS is always enabled and protects the main Flash program memory, data EEPROM and option bytes.

To perform in-application programming (IAP), this write protection can be removed by writing a MASS key sequence in a control register. This allows the application to write to data EEPROM, modify the contents of main program memory or the device option bytes.

A second level of write protection, can be enabled to further protect a specific area of memory known as UBC (user boot code). Refer to [Figure 2](#).

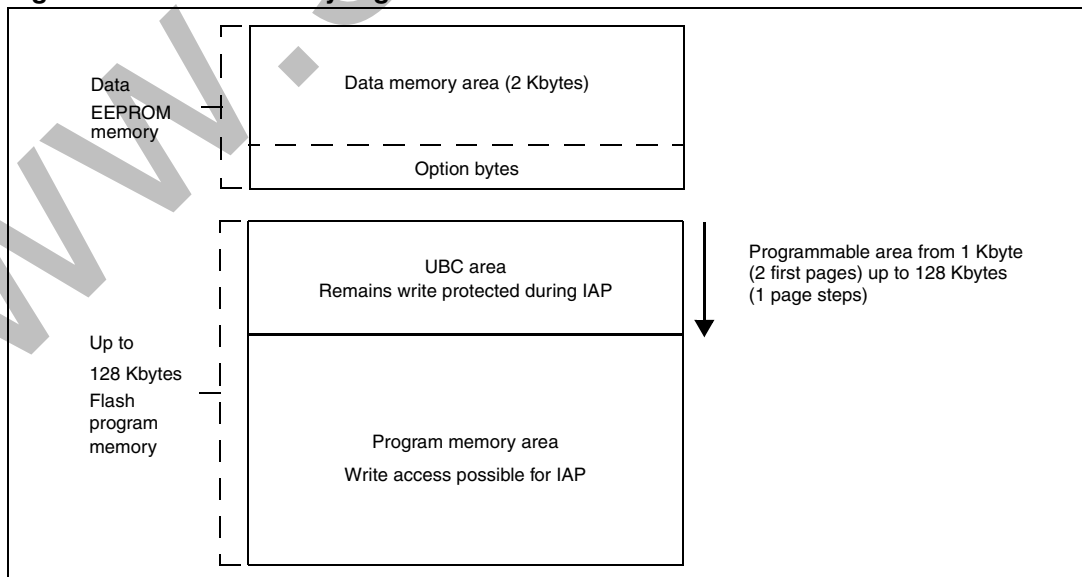
The size of the UBC is programmable through the UBC option byte ([Table 13](#)), in increments of 1 page (512 bytes) by programming the UBC option byte in ICP mode.

This divides the program memory into two areas:

- Main program memory: Up to 128 Kbytes minus UBC
- User-specific boot code (UBC): Configurable up to 128 Kbytes

The UBC area remains write-protected during in-application programming. This means that the MASS keys do not unlock the UBC area. It protects the memory used to store the boot program, specific code libraries, reset and interrupt vectors, the reset routine and usually the IAP and communication routines.

Figure 2. Flash memory organisation



Read-out protection (ROP)

The read-out protection blocks reading and writing the Flash program memory and data EEPROM memory in ICP mode (and debug mode). Once the read-out protection is activated, any attempt to toggle its status triggers a global erase of the program and data memory. Even if no protection can be considered as totally unbreakable, the feature provides a very high level of protection for a general purpose microcontroller.

4.5 Clock controller

The clock controller distributes the system clock (f_{MASTER}) coming from different oscillators to the core and the peripherals. It also manages clock gating for low power modes and ensures clock robustness.

Features

- **Clock prescaler:** To get the best compromise between speed and current consumption the clock frequency to the CPU and peripherals can be adjusted by a programmable prescaler.
- **Safe clock switching:** Clock sources can be changed safely on the fly in run mode through a configuration register. The clock signal is not switched until the new clock source is ready. The design guarantees glitch-free switching.
- **Clock management:** To reduce power consumption, the clock controller can stop the clock to the core, individual peripherals or memory.
- **Master clock sources:** Four different clock sources can be used to drive the master clock:
 - 1-24 MHz high-speed external crystal (HSE)
 - Up to 24 MHz high-speed user-external clock (HSE user-ext)
 - 16 MHz high-speed internal RC oscillator (HSI)
 - 128 kHz low-speed internal RC (LSI)
- **Startup clock:** After reset, the microcontroller restarts by default with an internal 2 MHz clock (HSI/8). The prescaler ratio and clock source can be changed by the application program as soon as the code execution starts.
- **Clock security system (CSS):** This feature can be enabled by software. If an HSE clock failure occurs, the internal RC (16 MHz/8) is automatically selected by the CSS and an interrupt can optionally be generated.
- **Configurable main clock output (CCO):** This outputs an external clock for use by the application.

Table 3. Peripheral clock gating bit assignments in CLK_PCKENR1/2 registers

Bit	Peripheral clock	Bit	Peripheral clock	Bit	Peripheral clock	Bit	Peripheral clock
PCKEN17	TIM1	PCKEN13	UART3	PCKEN27	beCAN	PCKEN23	ADC
PCKEN16	TIM3	PCKEN12	UART1	PCKEN26	Reserved	PCKEN22	AWU
PCKEN15	TIM2	PCKEN11	SPI	PCKEN25	Reserved	PCKEN21	Reserved
PCKEN14	TIM4	PCKEN10	I ² C	PCKEN24	Reserved	PCKEN20	Reserved

4.6 Power management

For efficient power management, the application can be put in one of four different low-power modes. You can configure each mode to obtain the best compromise between lowest power consumption, fastest start-up time and available wakeup sources.

- **Wait mode:** In this mode, the CPU is stopped, but peripherals are kept running. The wakeup is performed by an internal or external interrupt or reset.
- **Active halt mode with regulator on:** In this mode, the CPU and peripheral clocks are stopped. An internal wakeup is generated at programmable intervals by the auto wake up unit (AWU). The main voltage regulator is kept powered on, so current consumption is higher than in active halt mode with regulator off, but the wakeup time is faster. Wakeup is triggered by the internal AWU interrupt, external interrupt or reset.
- **Active halt mode with regulator off:** This mode is the same as active halt with regulator on, except that the main voltage regulator is powered off, so the wake up time is slower.
- **Halt mode:** In this mode the microcontroller uses the least power. The CPU and peripheral clocks are stopped, the main voltage regulator is powered off. Wakeup is triggered by external event or reset.

4.7 Watchdog timers

The watchdog system is based on two independent timers providing maximum security to the applications.

Activation of the watchdog timers is controlled by option bytes or by software. Once activated, the watchdogs cannot be disabled by the user program without performing a reset.

Window watchdog timer

The window watchdog is used to detect the occurrence of a software fault, usually generated by external interferences or by unexpected logical conditions, which cause the application program to abandon its normal sequence.

The window function can be used to trim the watchdog behavior to match the application perfectly.

The application software must refresh the counter before time-out and during a limited time window.

A reset is generated in two situations:

1. Timeout: At 16 MHz CPU clock the time-out period can be adjusted between 75 μ s up to 64 ms.
2. Refresh out of window: The downcounter is refreshed before its value is lower than the one stored in the window register.

Independent watchdog timer

The independent watchdog peripheral can be used to resolve processor malfunctions due to hardware or software failures.

It is clocked by the 128 kHz LSI internal RC clock source, and thus stays active even in case of a CPU clock failure

The IWDG time base spans from 60 μ s to 1 s.

4.8 Auto wakeup counter

- Used for auto wakeup from active halt mode
- Clock source: Internal 128 kHz internal low frequency RC oscillator or external clock
- LSI clock can be internally connected to TIM3 input capture channel 1 for calibration

4.9 Beeper

The beeper function outputs a signal on the BEEP pin for sound generation. The signal is in the range of 1, 2 or 4 kHz.

4.10 TIM1 - 16-bit advanced control timer

This is a high-end timer designed for a wide range of control applications. With its complementary outputs, dead-time control and center-aligned PWM capability, the field of applications is extended to motor control, lighting and half-bridge driver

- 16-bit up, down and up/down autoreload counter with 16-bit prescaler
- Four independent capture/compare channels (CAPCOM) configurable as input capture, output compare, PWM generation (edge and center aligned mode) and single pulse mode output
- Synchronization module to control the timer with external signals
- Break input to force the timer outputs into a defined state
- Three complementary outputs with adjustable dead time
- Encoder mode
- Interrupt sources: 3 x input capture/output compare, 1 x overflow/update, 1 x break

4.11 TIM2, TIM3 - 16-bit general purpose timers

- 16-bit autoreload (AR) up-counter
- 15-bit prescaler adjustable to fixed power of 2 ratios 1...32768
- Timers with 3 or 2 individually configurable capture/compare channels
- PWM mode
- Interrupt sources: 2 or 3 x input capture/output compare, 1 x overflow/update

4.12 TIM4 - 8-bit basic timer

- 8-bit autoreload, adjustable prescaler ratio to any power of 2 from 1 to 128
- Clock source: CPU clock
- Interrupt source: 1 x overflow/update

Table 4. TIM timer features

Timer	Counter size (bits)	Prescaler	Counting mode	CAPCOM channels	Complem. outputs	Ext. trigger	Timer synchronization/chaining
TIM1	16	Any integer from 1 to 65536	Up/down	4	3	Yes	No
TIM2	16	Any power of 2 from 1 to 32768	Up	3	0	No	
TIM3	16	Any power of 2 from 1 to 32768	Up	2	0	No	
TIM4	8	Any power of 2 from 1 to 128	Up	0	0	No	

4.13 Analog-to-digital converter (ADC2)

STM8S20xxx performance line products contain a 10-bit successive approximation A/D converter (ADC2) with up to 16 multiplexed input channels and the following main features:

- Input voltage range: 0 to V_{DDA}
- Dedicated voltage reference (VREF) pins available on 80 and 64-pin devices
- Conversion time: 14 clock cycles
- Single and continuous modes
- External trigger input
- Trigger from TIM1 TRGO
- End of conversion (EOC) interrupt

4.14 Communication interfaces

The following communication interfaces are implemented:

- UART1: Full feature UART, SPI emulation, LIN2.1 master capability, Smartcard mode, IrDA mode, single wire mode.
- UART3: Full feature UART, LIN2.1 master/slave capability
- SPI : Full and half-duplex, 10 Mbit/s
- I²C: Up to 400 Kbit/s
- beCAN (rev. 2.0A,B) - 3 Tx mailboxes - up to 1 Mbit/s

4.14.1 UART1

Main features

- One Mbit/s full duplex SCI
- SPI emulation
- High precision baud rate generator
- Smartcard emulation
- IrDA SIR encoder decoder
- LIN master mode
- Single wire half duplex mode

Asynchronous communication (UART mode)

- Full duplex communication - NRZ standard format (mark/space)
- Programmable transmit and receive baud rates up to 1 Mbit/s ($f_{CPU}/16$) and capable of following any standard baud rate regardless of the input frequency
- Separate enable bits for transmitter and receiver
- Two receiver wakeup modes:
 - Address bit (MSB)
 - Idle line (interrupt)
- Transmission error detection with interrupt generation
- Parity control

Synchronous communication

- Full duplex synchronous transfers
- SPI master operation
- 8-bit data communication
- Maximum speed: 1 Mbit/s at 16 MHz ($f_{CPU}/16$)

LIN master mode

- Emission: Generates 13-bit synch break frame
- Reception: Detects 11-bit break frame

4.14.2 UART3

Main features

- 1 Mbit/s full duplex SCI
- LIN master capable
- High precision baud rate generator

Asynchronous communication (UART mode)

- Full duplex communication - NRZ standard format (mark/space)
- Programmable transmit and receive baud rates up to 1 Mbit/s ($f_{CPU}/16$) and capable of following any standard baud rate regardless of the input frequency
- Separate enable bits for transmitter and receiver
- Two receiver wakeup modes:
 - Address bit (MSB)
 - Idle line (interrupt)
- Transmission error detection with interrupt generation
- Parity control

LIN master capability

- Emission: Generates 13-bit synch break frame
- Reception: Detects 11-bit break frame

LIN slave mode

- Autonomous header handling - one single interrupt per valid message header
- Automatic baud rate synchronization - maximum tolerated initial clock deviation $\pm 15\%$
- Synch delimiter checking
- 11-bit LIN synch break detection - break detection always active
- Parity check on the LIN identifier field
- LIN error management
- Hot plugging support

4.14.3 SPI

- Maximum speed: 10 Mbit/s ($f_{MASTER}/2$) both for master and slave
- Full duplex synchronous transfers
- Simplex synchronous transfers on two lines with a possible bidirectional data line
- Master or slave operation - selectable by hardware or software
- CRC calculation
- 1 byte Tx and Rx buffer
- Slave/master selection input pin

4.14.4 I²C

- I²C master features:
 - Clock generation
 - Start and stop generation
- I²C slave features:
 - Programmable I²C address detection
 - Stop bit detection
- Generation and detection of 7-bit/10-bit addressing and general call
- Supports different communication speeds:
 - Standard speed (up to 100 kHz)
 - Fast speed (up to 400 kHz)

4.14.5 beCAN

The beCAN controller (basic enhanced CAN), interfaces the CAN network and supports the CAN protocol version 2.0A and B. It has been designed to manage a high number of incoming messages efficiently with a minimum CPU load.

For safety-critical applications the beCAN controller provides all hardware functions to support the CAN time triggered communication option (TTCAN).

The maximum transmission speed is 1 Mbit.

Transmission

- Three transmit mailboxes
- Configurable transmit priority by identifier or order request
- Time stamp on SOF transmission

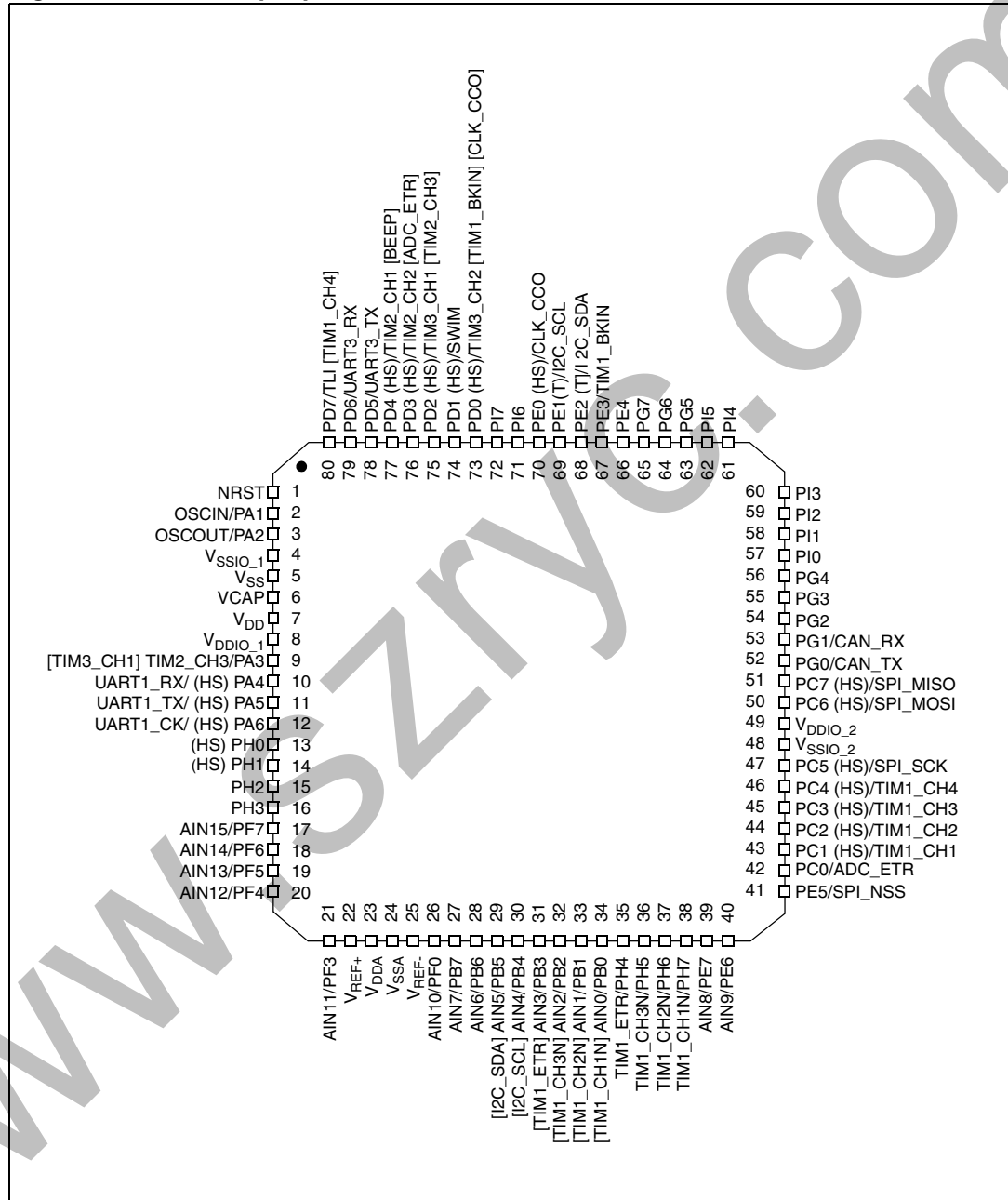
Reception

- 8-, 11- and 29-bit ID
- One receive FIFO (3 messages deep)
- Software-efficient mailbox mapping at a unique address space
- FMI (filter match index) stored with message
- Configurable FIFO overrun
- Time stamp on SOF reception
- Six filter banks, 2 x 32 bytes (scalable to 4 x 16-bit) each, enabling various masking configurations, such as 12 filters for 29-bit ID or 48 filters for 11-bit ID
- Filtering modes:
 - Mask mode permitting ID range filtering
 - ID list mode
- Time triggered communication option
 - Disable automatic retransmission mode
 - 16-bit free running timer
 - Configurable timer resolution
 - Time stamp sent in last two data bytes

5 Pinouts and pin description

5.1 Package pinouts

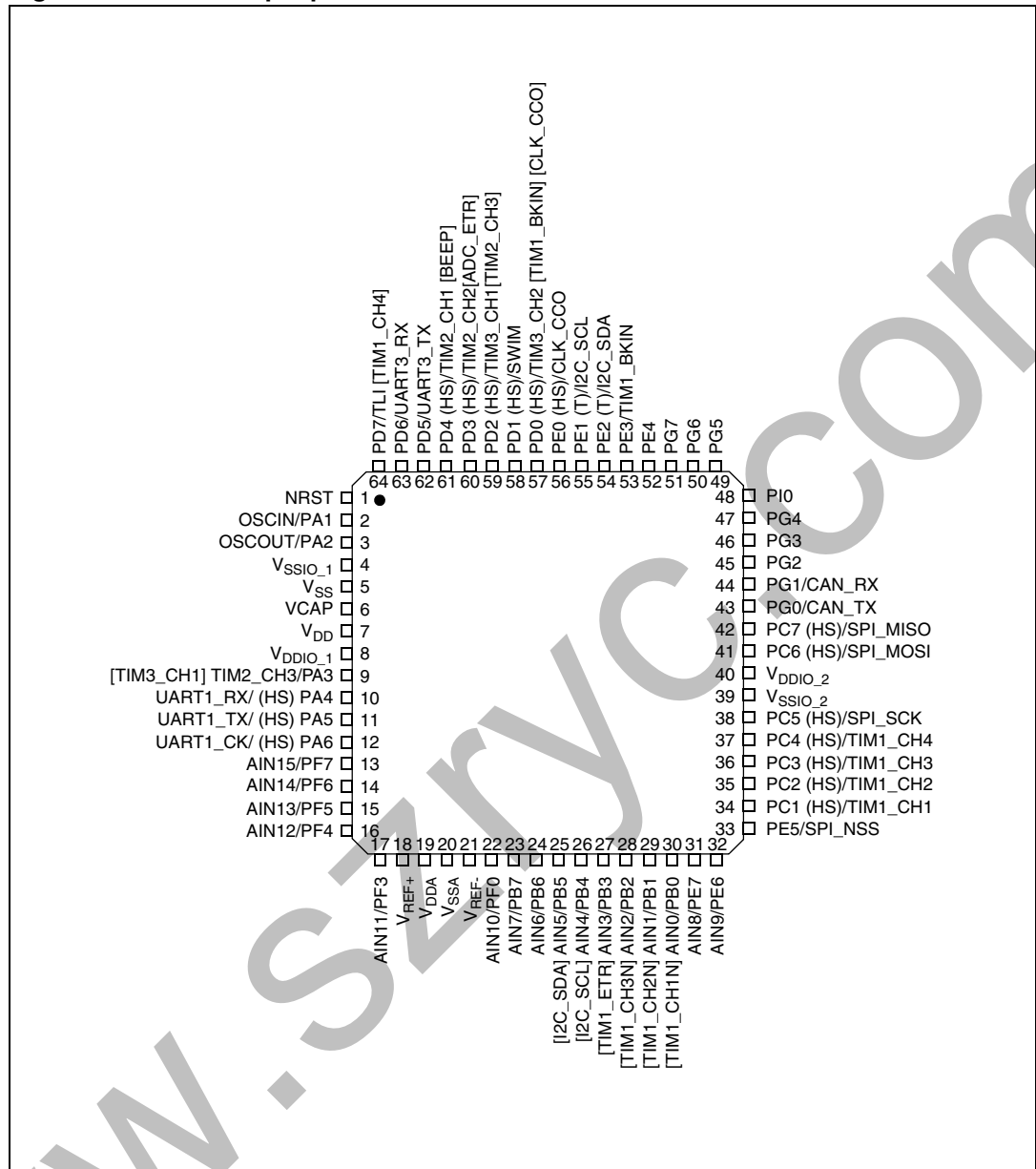
Figure 3. LQFP 80-pin pinout



1. (HS) high sink capability.
2. (T) True open drain (P-buffer and protection diode to V_{DD} not implemented).
3. [] alternate function remapping option (If the same alternate function is shown twice, it indicates an exclusive choice not a duplication of the function).
4. CAN_RX and CAN_TX is available on STM8S208xx devices only.



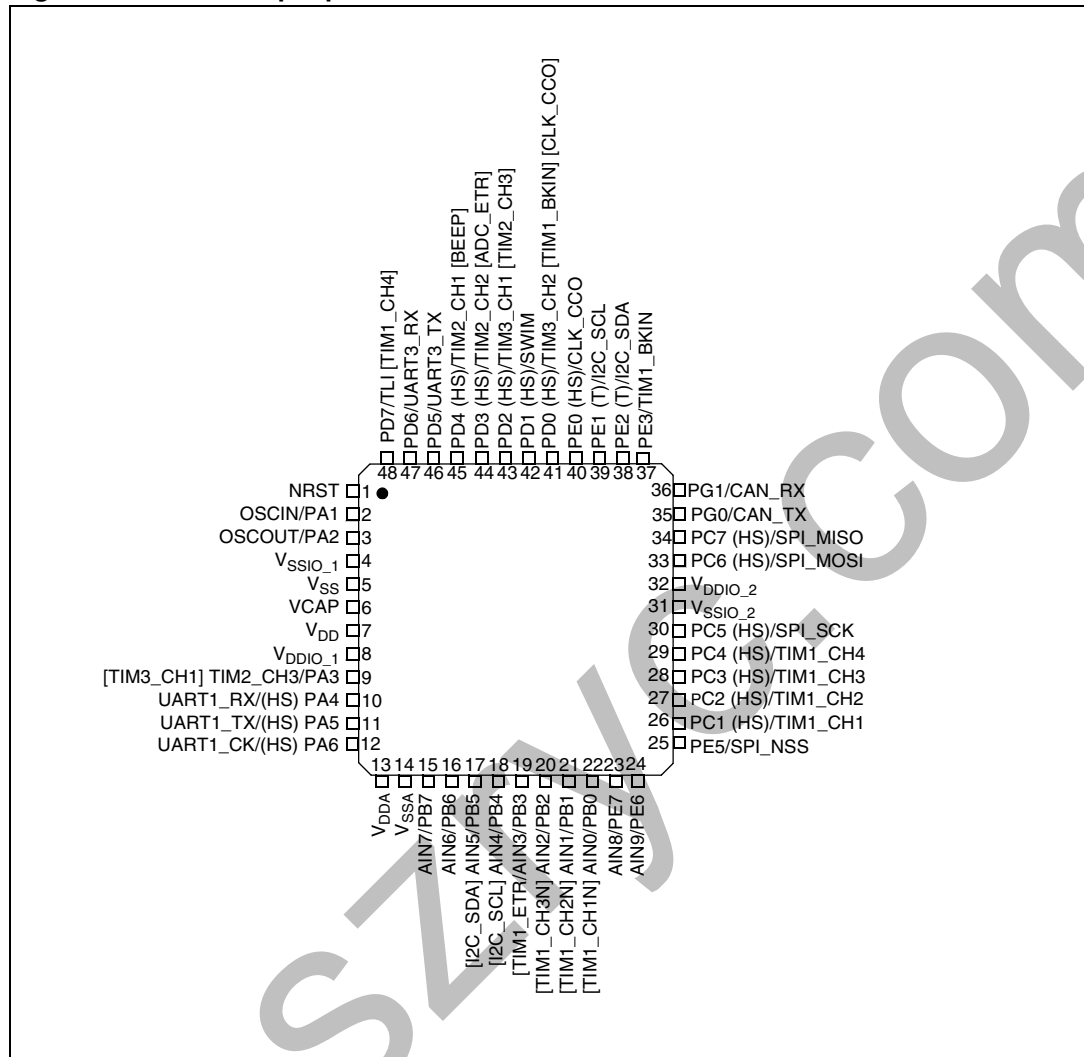
Figure 4. LQFP 64-pin pinout



- 1. (HS) high sink capability.
- 2. (T) True open drain (P-buffer and protection diode to V_{DD} not implemented).
- 3. [] alternate function remapping option (If the same alternate function is shown twice, it indicates an exclusive choice not a duplication of the function).
- 4. CAN_RX and CAN_TX is available on STM8S208xx devices only.

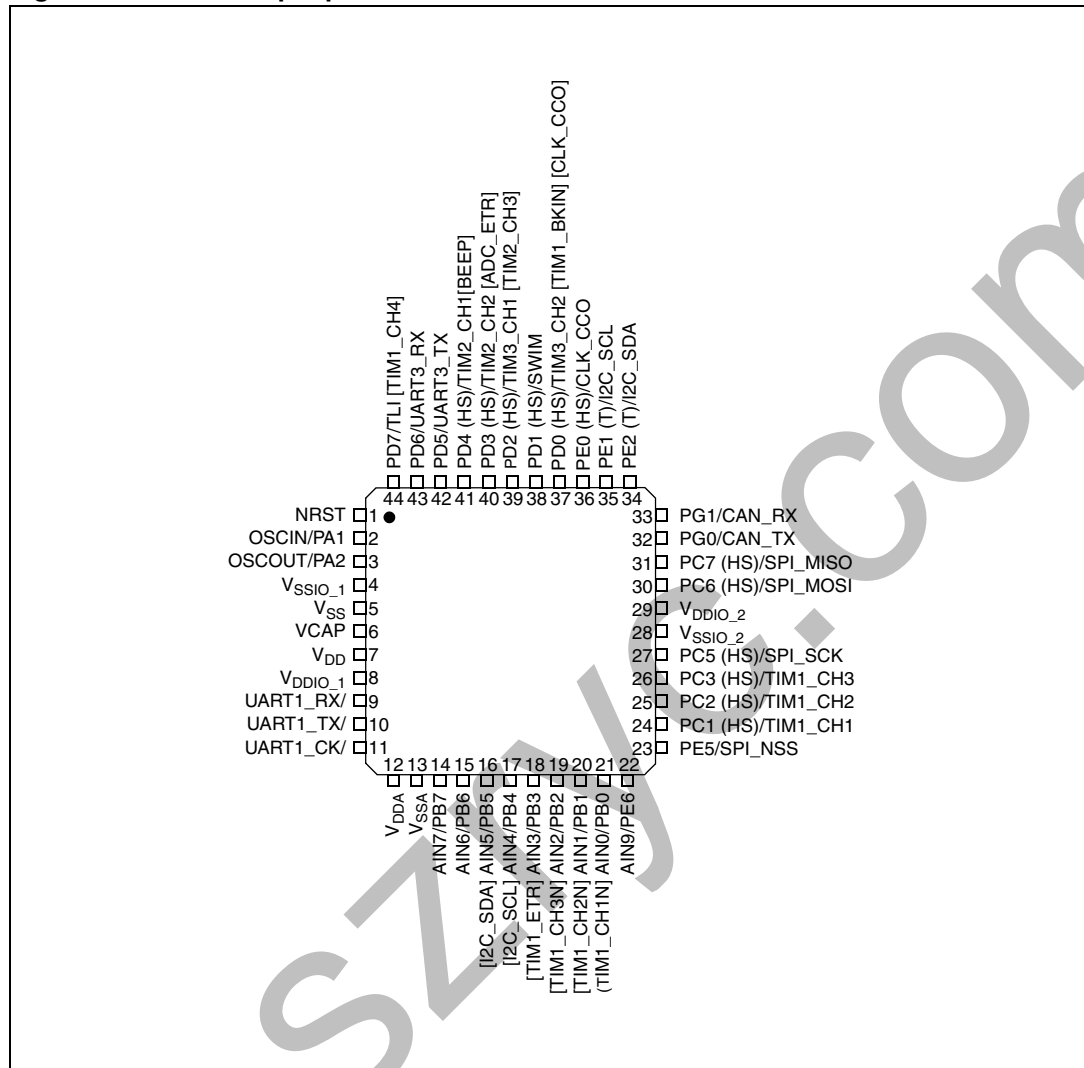


Figure 5. LQFP 48-pin pinout



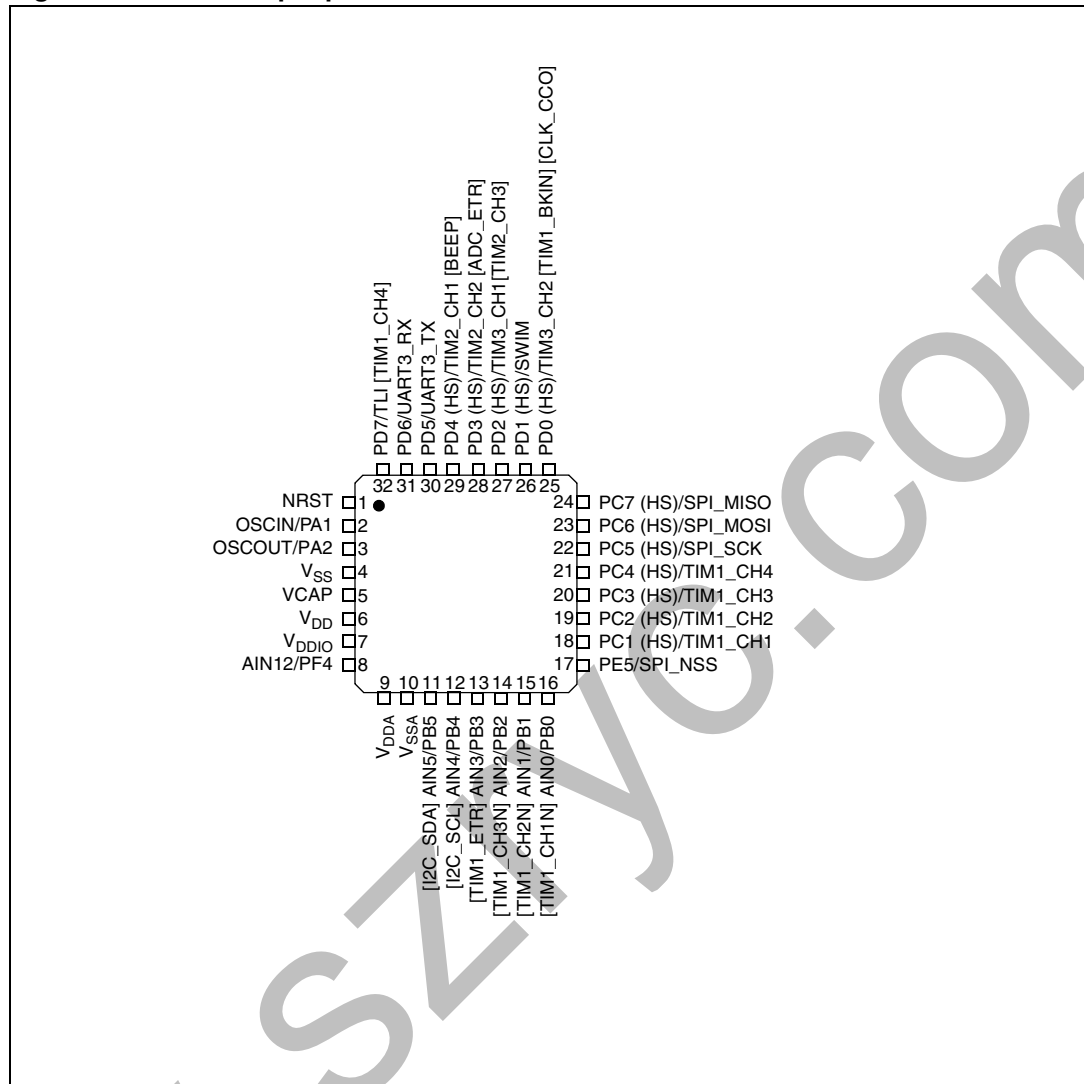
1. (HS) high sink capability.
2. (T) True open drain (P-buffer and protection diode to V_{DD} not implemented).
3. [] alternate function remapping option (If the same alternate function is shown twice, it indicates an exclusive choice not a duplication of the function).
4. CAN_RX and CAN_TX is available on STM8S208xx devices only.

Figure 6. LQFP 44-pin pinout



1. (HS) high sink capability.
2. (T) True open drain (P-buffer and protection diode to V_{DD} not implemented).
3. [] alternate function remapping option (If the same alternate function is shown twice, it indicates an exclusive choice not a duplication of the function).
4. CAN_RX and CAN_TX is available on STM8S208xx devices only.

Figure 7. LQFP 32-pin pinout



1. (HS) high sink capability.
2. [] alternate function remapping option (If the same alternate function is shown twice, it indicates an exclusive choice not a duplication of the function).

Table 5. Legend/abbreviations

Type	I= Input, O = Output, S = Power supply	
Level	Input	CM = CMOS
	Output	HS = High sink
Output speed	O1 = Slow (up to 2 MHz) O2 = Fast (up to 10 MHz) O3 = Fast/slow programmability with slow as default state after reset O4 = Fast/slow programmability with fast as default state after reset	
Port and control configuration	Input	float = floating, wpu = weak pull-up
	Output	T = True open drain, OD = Open drain, PP = Push pull
Reset state	Bold X	

Table 6. Pin description

Pin number					Pin name	Type	Input			Output				Main function (after reset)	Default alternate function	Alternate function after remap [option bit]
LQFP80	LQFP64	LQFP48	LQFP44	LQFP32			floating	wpu	Ext. interrupt	High sink	Speed	OD	PP			
1	1	1	1	1	NRST	I/O		X						Reset		
2	2	2	2	2	PA1/OSCIN	I/O	X	X			O1	X	X	Port A1	Resonator/crystal in	
3	3	3	3	3	PA2/OSCOU	I/O	X	X	X		O1	X	X	Port A2	Resonator/crystal out	
4	4	4	4	-	V _{SSIO_1}	S								I/O ground		
5	5	5	5	4	V _{SS}	S								Digital ground		
6	6	6	6	5	VCAP	S								1.8 V regulator capacitor		
7	7	7	7	6	V _{DD}	S								Digital power supply		
8	8	8	8	7	V _{DDIO_1}	S								I/O power supply		
9	9	9	-	-	PA3/TIM2_CH3	I/O	X	X	X		O1	X	X	Port A3	Timer 2 - channel3	TIM3_CH1 [AFR1]
10	10	10	9	-	PA4/UART1_RX ⁽¹⁾	I/O	X	X	X	HS	O3	X	X	Port A4	UART1 receive	
11	11	11	10	-	PA5/UART1_TX	I/O	X	X	X	HS	O3	X	X	Port A5	UART1 transmit	
12	12	12	11	-	PA6/UART1_CK	I/O	X	X	X	HS	O3	X	X	Port A6	UART1 synchronous clock	
13	-	-	-	-	PH0	I/O	X	X		HS	O3	X	X	Port H0		
14	-	-	-	-	PH1	I/O	X	X		HS	O3	X	X	Port H1		
15	-	-	-	-	PH2	I/O	X	X			O1	X	X	Port H2		
16	-	-	-	-	PH3	I/O	X	X			O1	X	X	Port H3		
17	13	-	-	-	PF7/AIN15	I/O	X	X			O1	X	X	Port F7	Analog input 15	
18	14	-	-	-	PF6/AIN14	I/O	X	X			O1	X	X	Port F6	Analog input 14	
19	15	-	-	-	PF5/AIN13	I/O	X	X			O1	X	X	Port F5	Analog input 13	
20	16	-	-	8	PF4/AIN12	I/O	X	X			O1	X	X	Port F4	Analog input 12	
21	17	-	-	-	PF3/AIN11	I/O	X	X			O1	X	X	Port F3	Analog input 11	
22	18	-	-	-	V _{REF+}	S								ADC positive reference voltage		
23	19	13	12	9	V _{DDA}	S								Analog power supply		



Table 6. Pin description (continued)

Pin number					Pin name	Type	Input			Output				Main function (after reset)	Default alternate function	Alternate function after remap [option bit]
LQFP80	LQFP64	LQFP48	LQFP44	LQFP32			floating	wpu	Ext. interrupt	High sink	Speed	OD	PP			
24	20	14	13	10	V _{SSA}	S								Analog ground		
25	21	-	-	-	V _{REF-}	S								ADC negative reference voltage		
26	22	-	-	-	PF0/AIN10	I/O	X	X		O1	X	X	Port F0	Analog input 10		
27	23	15	14	-	PB7/AIN7	I/O	X	X	X	O1	X	X	Port B7	Analog input 7		
28	24	16	15	-	PB6/AIN6	I/O	X	X	X	O1	X	X	Port B6	Analog input 6		
29	25	17	16	11	PB5/AIN5	I/O	X	X	X	O1	X	X	Port B5	Analog input 5	I ² C_SDA [AFR6]	
30	26	18	17	12	PB4/AIN4	I/O	X	X	X	O1	X	X	Port B4	Analog input 4	I ² C_SCL [AFR6]	
31	27	19	18	13	PB3/AIN3	I/O	X	X	X	O1	X	X	Port B3	Analog input 3	TIM1_ETR [AFR5]	
32	28	20	19	14	PB2/AIN2	I/O	X	X	X	O1	X	X	Port B2	Analog input 2	TIM1_CH3N [AFR5]	
33	29	21	20	15	PB1/AIN1	I/O	X	X	X	O1	X	X	Port B1	Analog input 1	TIM1_CH2N [AFR5]	
34	30	22	21	16	PB0/AIN0	I/O	X	X	X	O1	X	X	Port B0	Analog input 0	TIM1_CH1N [AFR5]	
35	-	-	-	-	PH4/TIM1_ETR	I/O	X	X		O1	X	X	Port H4	Timer 1 - trigger input		
36	-	-	-	-	PH5/ TIM1_CH3N	I/O	X	X		O1	X	X	Port H5	Timer 1 - inverted channel 3		
37	-	-	-	-	PH6/ TIM1_CH2N	I/O	X	X		O1	X	X	Port H6	Timer 1 - inverted channel 2		
38	-	-	-	-	PH7/ TIM1_CH1N	I/O	X	X		O1	X	X	Port H7	Timer 1 - inverted channel 2		
39	31	23	-	-	PE7/AIN8	I/O	X	X	X	O1	X	X	Port E7	Analog input 8		
40	32	24	22	-	PE6/AIN9	I/O	X	X	X	O1	X	X	Port E6	Analog input 9		

Table 6. Pin description (continued)

Pin number					Pin name	Type	Input			Output				Main function (after reset)	Default alternate function	Alternate function after remap [option bit]
LQFP80	LQFP64	LQFP48	LQFP44	LQFP32			floating	wpu	Ext. interrupt	High sink	Speed	OD	PP			
41	33	25	23	17	PE5/SPI_NSS	I/O	X	X	X		O1	X	X	Port E5	SPI master/slave select	
42	-	-	-	-	PC0/ADC_ETR	I/O	X	X	X		O1	X	X	Port C0	ADC trigger input	
43	34	26	24	18	PC1/TIM1_CH1	I/O	X	X	X	HS	O3	X	X	Port C1	Timer 1 - channel 1	
44	35	27	25	19	PC2/TIM1_CH2	I/O	X	X	X	HS	O3	X	X	Port C2	Timer 1 - channel 2	
45	36	28	26	20	PC3/TIM1_CH3	I/O	X	X	X	HS	O3	X	X	Port C3	Timer 1 - channel 3	
46	37	29	-	21	PC4/TIM1_CH4	I/O	X	X	X	HS	O3	X	X	Port C4	Timer 1 - channel 4	
47	38	30	27	22	PC5/SPI_SCK	I/O	X	X	X	HS	O3	X	X	Port C5	SPI clock	
48	39	31	28	-	V _{SSIO_2}	S									I/O ground	
49	40	32	29	-	V _{DDIO_2}	S									I/O power supply	
50	41	33	30	23	PC6/SPI_MOSI	I/O	X	X	X	HS	O3	X	X	Port C6	SPI master out/ slave in	
51	42	34	31	24	PC7/SPI_MISO	I/O	X	X	X	HS	O3	X	X	Port C7	SPI master in/ slave out	
52	43	35	32	-	PG0/CAN_TX ⁽²⁾	I/O	X	X			O1	X	X	Port G0	beCAN transmit	
53	44	36	33	-	PG1/CAN_RX ⁽²⁾	I/O	X	X			O1	X	X	Port G1	beCAN receive	
54	45	-	-	-	PG2	I/O	X	X			O1	X	X	Port G2		
55	46	-	-	-	PG3	I/O	X	X			O1	X	X	Port G3		
56	47	-	-	-	PG4	I/O	X	X			O1	X	X	Port G4		
57	48	-	-	-	PI0	I/O	X	X			O1	X	X	Port I0		
58	-	-	-	-	PI1	I/O	X	X			O1	X	X	Port I1		
59	-	-	-	-	PI2	I/O	X	X			O1	X	X	Port I2		
60	-	-	-	-	PI3	I/O	X	X			O1	X	X	Port I3		
61	-	-	-	-	PI4	I/O	X	X			O1	X	X	Port I4		
62	-	-	-	-	PI5	I/O	X	X			O1	X	X	Port I5		
63	49	-	-	-	PG5	I/O	X	X			O1	X	X	Port G5		
64	50	-	-	-	PG6	I/O	X	X			O1	X	X	Port G6		



Table 6. Pin description (continued)

Pin number					Pin name	Type	Input			Output				Main function (after reset)	Default alternate function	Alternate function after remap [option bit]
LQFP80	LQFP64	LQFP48	LQFP44	LQFP32			floating	wpu	Ext. interrupt	High sink	Speed	OD	PP			
65	51	-	-	-	PG7	I/O	X	X		O1	X	X	Port G7			
66	52	-	-	-	PE4	I/O	X	X	X	O1	X	X	Port E4			
67	53	37	-	-	PE3/TIM1_BKIN	I/O	X	X	X	O1	X	X	Port E3	Timer 1 - break input		
68	54	38	34	-	PE2/I ² C_SDA	I/O	X		X	O1	T ⁽³⁾		Port E2	I ² C data		
69	55	39	35	-	PE1/I ² C_SCL	I/O	X		X	O1	T ⁽³⁾		Port E1	I ² C clock		
70	56	40	36	-	PE0/CLK_CCO	I/O	X	X	X	HS	O3	X	X	Port E0	Configurable clock output	
71	-	-	-	-	PI6	I/O	X	X		O1	X	X	Port I6			
72	-	-	-	-	PI7	I/O	X	X		O1	X	X	Port I7			
73	57	41	37	25	PD0/TIM3_CH2	I/O	X	X	X	HS	O3	X	X	Port D0	Timer 3 - channel 2	TIM1_BKIN [AFR3]/CLK_CCO [AFR2]
74	58	42	38	26	PD1/SWIM	I/O	X	X	X	HS	O4	X	X	Port D1	SWIM data interface	
75	59	43	39	27	PD2/TIM3_CH1	I/O	X	X	X	HS	O3	X	X	Port D2	Timer 3 - channel 1	TIM2_CH3 [AFR1]
76	60	44	40	28	PD3/TIM2_CH2	I/O	X	X	X	HS	O3	X	X	Port D3	Timer 2 - channel 2	ADC_ETR [AFR0]
77	61	45	41	29	PD4/TIM2_CH1/BEEP	I/O	X	X	X	HS	O3	X	X	Port D4	Timer 2 - channel 1	BEEP output [AFR7]
78	62	46	42	30	PD5/ UART3_TX	I/O	X	X	X		O1	X	X	Port D5	UART3 data transmit	
79	63	47	43	31	PD6/ UART3_RX ⁽¹⁾	I/O	X	X	X		O1	X	X	Port D6	UART3 data receive	
80	64	48	44	32	PD7/TLI	I/O	X	X	X		O1	X	X	Port D7	Top level interrupt	TIM1_CH4 [AFR4]

1. The default state of UART1_RX and UART3_RX pins is controlled by the ROM bootloader. These pins are pulled up as part of the bootloader activation process and returned to the floating state before a return from the bootloader.
2. The beCAN interface is available on STM8S208xx devices only
3. In the open-drain output column, 'T' defines a true open-drain I/O (P-buffer and protection diode to V_{DD} are not implemented).

5.2 Alternate function remapping

As shown in the rightmost column of the pin description table, some alternate functions can be remapped at different I/O ports by programming one of eight AFR (alternate function remap) option bits. Refer to [Section 8: Option bytes on page 47](#). When the remapping option is active, the default alternate function is no longer available.

To use an alternate function, the corresponding peripheral must be enabled in the peripheral registers.

Alternate function remapping does not effect GPIO capabilities of the I/O ports (see the GPIO section of the family reference manual, RM0016).

6 Memory and register map

6.1 Memory map

Figure 8. Memory map

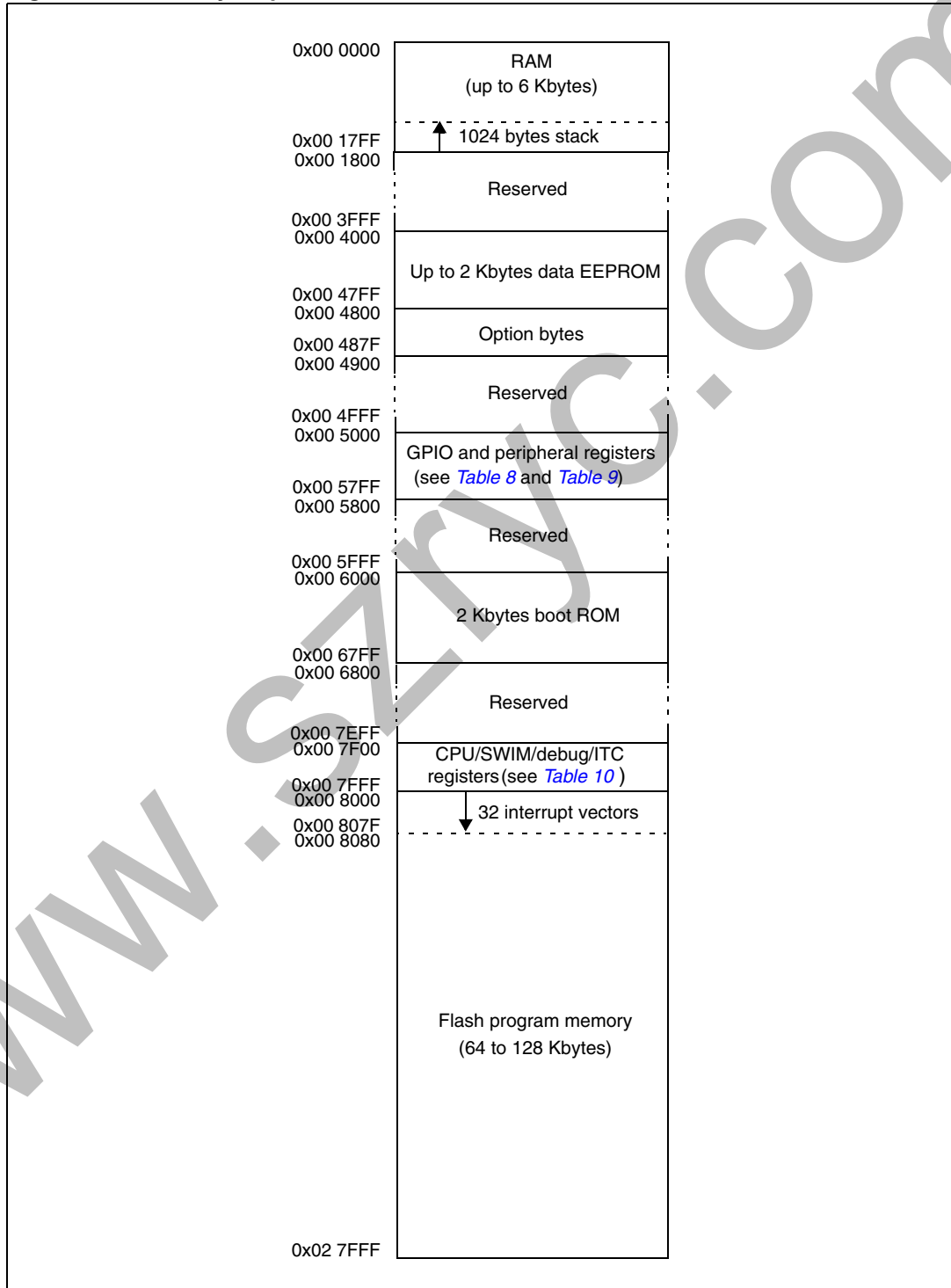


Table 7 lists the boundary addresses for each memory size. The top of the stack is at the RAM end address in each case.

Table 7. Flash, Data EEPROM and RAM boundary addresses

Memory area	Size (bytes)	Start address	End address
Flash program memory	128 K	0x00 8000	0x02 7FFF
	64 K	0x00 8000	0x01 7FFF
	32 K	0x00 8000	0x00 FFFF
RAM	6 K	0x00 0000	0x00 17FF
	4 K	0x00 0000	0x00 1000
	2 K	0x00 0000	0x00 07FF
Data EEPROM	2048	0x00 4000	0x00 47FF
	1536	0x00 4000	0x00 45FF
	1024	0x00 4000	0x00 43FF

6.2 Register map

Table 8. I/O port hardware register map

Address	Block	Register label	Register name	Reset status
0x00 5000	Port A	PA_ODR	Port A data output latch register	0x00
0x00 5001		PA_IDR	Port A input pin value register	0x00
0x00 5002		PA_DDR	Port A data direction register	0x00
0x00 5003		PA_CR1	Port A control register 1	0x00
0x00 5004		PA_CR2	Port A control register 2	0x00
0x00 5005	Port B	PB_ODR	Port B data output latch register	0x00
0x00 5006		PB_IDR	Port B input pin value register	0x00
0x00 5007		PB_DDR	Port B data direction register	0x00
0x00 5008		PB_CR1	Port B control register 1	0x00
0x00 5009		PB_CR2	Port B control register 2	0x00
0x00 500A	Port C	PC_ODR	Port C data output latch register	0x00
0x00 500B		PC_IDR	Port C input pin value register	0x00
0x00 500C		PC_DDR	Port C data direction register	0x00
0x00 500D		PC_CR1	Port C control register 1	0x00
0x00 500E		PC_CR2	Port C control register 2	0x00

Table 8. I/O port hardware register map (continued)

Address	Block	Register label	Register name	Reset status
0x00 500F	Port D	PD_ODR	Port D data output latch register	0x00
0x00 5010		PD_IDR	Port D input pin value register	0x00
0x00 5011		PD_DDR	Port D data direction register	0x00
0x00 5012		PD_CR1	Port D control register 1	0x02
0x00 5013		PD_CR2	Port D control register 2	0x00
0x00 5014	Port E	PE_ODR	Port E data output latch register	0x00
0x00 5015		PE_IDR	Port E input pin value register	0x00
0x00 5016		PE_DDR	Port E data direction register	0x00
0x00 5017		PE_CR1	Port E control register 1	0x00
0x00 5018		PE_CR2	Port E control register 2	0x00
0x00 5019	Port F	PF_ODR	Port F data output latch register	0x00
0x00 501A		PF_IDR	Port F input pin value register	0x00
0x00 501B		PF_DDR	Port F data direction register	0x00
0x00 501C		PF_CR1	Port F control register 1	0x00
0x00 501D		PF_CR2	Port F control register 2	0x00
0x00 501E	Port G	PG_ODR	Port G data output latch register	0x00
0x00 501F		PG_IDR	Port G input pin value register	0x00
0x00 5020		PG_DDR	Port G data direction register	0x00
0x00 5021		PG_CR1	Port G control register 1	0x00
0x00 5022		PG_CR2	Port G control register 2	0x00
0x00 5023	Port H	PH_ODR	Port H data output latch register	0x00
0x00 5024		PH_IDR	Port H input pin value register	0x00
0x00 5025		PH_DDR	Port H data direction register	0x00
0x00 5026		PH_CR1	Port H control register 1	0x00
0x00 5027		PH_CR2	Port H control register 2	0x00
0x00 5028	Port I	PI_ODR	Port I data output latch register	0x00
0x00 5029		PI_IDR	Port I input pin value register	0x00
0x00 502A		PI_DDR	Port I data direction register	0x00
0x00 502B		PI_CR1	Port I control register 1	0x00
0x00 502C		PI_CR2	Port I control register 2	0x00

Table 9. General hardware register map

Address	Block	Register label	Register name	Reset status
0x00 5050 to 0x00 5059	Reserved area (10 bytes)			
0x00 505A	Flash	FLASH_CR1	Flash control register 1	0x00
0x00 505B		FLASH_CR2	Flash control register 2	0x00
0x00 505C		FLASH_NCR2	Flash complementary control register 2	0xFF
0x00 505D		FLASH_FPR	Flash protection register	0x00
0x00 505E		FLASH_NFPR	Flash complementary protection register	0xFF
0x00 505F		FLASH_IAPSR	Flash in-application programming status register	0x00
0x00 5060 to 0x00 5061	Reserved area (2 bytes)			
0x00 5062	Flash	FLASH_PUKR	Flash Program memory unprotection register	0x00
0x00 5063	Reserved area (1 byte)			
0x00 5064	Flash	FLASH_DUKR	Data EEPROM unprotection register	0x00
0x00 5065 to 0x00 509F	Reserved area (59 bytes)			
0x00 50A0	ITC	EXTI_CR1	External interrupt control register 1	0x00
0x00 50A1		EXTI_CR2	External interrupt control register 2	0x00
0x00 50A2 to 0x00 50B2	Reserved area (17 bytes)			
0x00 50B3	RST	RST_SR	Reset status register	xx
0x00 50B4 to 0x00 50BF	Reserved area (12 bytes)			
0x00 50C0	CLK	CLK_ICKR	Internal clock control register	0x01
0x00 50C1		CLK_ECKR	External clock control register	0x00
0x00 50C2	Reserved area (1 byte)			

Table 9. General hardware register map (continued)

Address	Block	Register label	Register name	Reset status
0x00 50C3	CLK	CLK_CMSR	Clock master status register	0xE1
0x00 50C4		CLK_SWR	Clock master switch register	0xE1
0x00 50C5		CLK_SWCR	Clock switch control register	0bxxxx0000
0x00 50C6		CLK_CKDIVR	Clock divider register	0x18
0x00 50C7		CLK_PCKENR1	Peripheral clock gating register 1	0xFF
0x00 50C8		CLK_CSSR	Clock security system register	0x00
0x00 50C9		CLK_CCOR	Configurable clock control register	0x00
0x00 50CA		CLK_PCKENR2	Peripheral clock gating register 2	0xFF
0x00 50CB		CLK_CANCCR	CAN clock control register	0x00
0x00 50CC		CLK_HSITRIMR	HSI clock calibration trimming register	xx
0x00 50CD		CLK_SWIMCCR	SWIM clock control register	x0
0x00 50CE to 0x00 50D0	Reserved area (3 bytes)			
0x00 50D1	WWDG	WWDG_CR	WWDG control register	0x7F
0x00 50D2		WWDG_WR	WWDG window register	0x7F
0x00 50D3 to 0x00 50DF	Reserved area (13 bytes)			
0x00 50E0	IWDG	IWDG_KR	IWDG key register	-
0x00 50E1		IWDG_PR	IWDG prescaler register	0x00
0x00 50E2		IWDG_RLR	IWDG reload register	0xFF
0x00 50E3 to 0x00 50EF	Reserved area (13 bytes)			
0x00 50F0	AWU	AWU_CSR1	AWU control/status register 1	0x00
0x00 50F1		AWU_APR	AWU asynchronous prescaler buffer register	0x3F
0x00 50F2		AWU_TBR	AWU timebase selection register	0x00
0x00 50F3	BEEP	BEEP_CSR	BEEP control/status register	0x1F
0x00 50F4 to 0x00 50FF	Reserved area (12 bytes)			

Table 9. General hardware register map (continued)

Address	Block	Register label	Register name	Reset status	
00 5200h	SPI	SPI_CR1	SPI control register 1	0x00	
00 5201h		SPI_CR2	SPI control register 2	0x00	
00 5202h		SPI_ICR	SPI interrupt control register	0x00	
00 5203h		SPI_SR	SPI status register	0x02	
00 5204h		SPI_DR	SPI data register	0x00	
00 5205h		SPI_CRCPR	SPI CRC polynomial register	0x07	
00 5206h		SPI_RXCR	SPI Rx CRC register	0xFF	
00 5207h		SPI_TXCR	SPI Tx CRC register	0xFF	
00 5208h to 00 520Fh	Reserved area (8 bytes)				
00 5210h	I ² C	I2C_CR1	I ² C control register 1	0x00	
00 5211h		I2C_CR2	I ² C control register 2	0x00	
00 5212h		I2C_FREQR	I ² C frequency register	0x00	
00 5213h		I2C_OARL	I ² C own address register low	0x00	
00 5214h		I2C_OARH	I ² C own address register high	0x00	
00 5215h		Reserved			
00 5216h		I2C_DR	I ² C data register	0x00	
00 5217h		I2C_SR1	I ² C status register 1	0x00	
00 5218h		I2C_SR2	I ² C status register 2	0x00	
00 5219h		I2C_SR3	I ² C status register 3	0x00	
00 521Ah		I2C_ITR	I ² C interrupt control register	0x00	
00 521Bh		I2C_CCRL	I ² C clock control register low	0x00	
00 521Ch		I2C_CCRH	I ² C clock control register high	0x00	
00 521Dh		I2C_TRISER	I ² C TRISE register	0x02	
00 521Eh		I2C_PECR	I ² C packet error checking register	0x00	
00 521Fh to 00 522Fh	Reserved area (17 bytes)				

Table 9. General hardware register map (continued)

Address	Block	Register label	Register name	Reset status	
0x00 5230	UART1	UART1_SR	UART1 status register	0xC0	
0x00 5231		UART1_DR	UART1 data register	xx	
0x00 5232		UART1_BRR1	UART1 baud rate register 1	0x00	
0x00 5233		UART1_BRR2	UART1 baud rate register 2	0x00	
0x00 5234		UART1_CR1	UART1 control register 1	0x00	
0x00 5235		UART1_CR2	UART1 control register 2	0x00	
0x00 5236		UART1_CR3	UART1 control register 3	0x00	
0x00 5237		UART1_CR4	UART1 control register 4	0x00	
0x00 5238		UART1_CR5	UART1 control register 5	0x00	
0x00 5239		UART1_GTR	UART1 guard time register	0x00	
0x00 523A		UART1_PSCR	UART1 prescaler register	0x00	
0x00 523B to 0x00 523F		Reserved area (5 bytes)			
0x00 5240	UART3	UART3_SR	UART3 status register	C0h	
0x00 5241		UART3_DR	UART3 data register	xx	
0x00 5242		UART3_BRR1	UART3 baud rate register 1	0x00	
0x00 5243		UART3_BRR2	UART3 baud rate register 2	0x00	
0x00 5244		UART3_CR1	UART3 control register 1	0x00	
0x00 5245		UART3_CR2	UART3 control register 2	0x00	
0x00 5246		UART3_CR3	UART3 control register 3	0x00	
005247		UART3_CR4	UART3 control register 4	0x00	
0x00 5248		Reserved			
0x00 5249		UART3_CR6	UART3 control register 6	0x00	
0x00 524A to 0x00 524F	Reserved area (6 bytes)				

Table 9. General hardware register map (continued)

Address	Block	Register label	Register name	Reset status
0x00 5250	TIM1	TIM1_CR1	TIM1 control register 1	0x00
0x00 5251		TIM1_CR2	TIM1 control register 2	0x00
0x00 5252		TIM1_SMCR	TIM1 slave mode control register	0x00
0x00 5253		TIM1_ETR	TIM1 external trigger register	0x00
0x00 5254		TIM1_IER	TIM1 Interrupt enable register	0x00
0x00 5255		TIM1_SR1	TIM1 status register 1	0x00
0x00 5256		TIM1_SR2	TIM1 status register 2	0x00
0x00 5257		TIM1_EGR	TIM1 event generation register	0x00
0x00 5258		TIM1_CCMR1	TIM1 capture/compare mode register 1	0x00
0x00 5259		TIM1_CCMR2	TIM1 capture/compare mode register 2	0x00
0x00 525A		TIM1_CCMR3	TIM1 capture/compare mode register 3	0x00
0x00 525B		TIM1_CCMR4	TIM1 capture/compare mode register 4	0x00
0x00 525C		TIM1_CCER1	TIM1 capture/compare enable register 1	0x00
0x00 525D		TIM1_CCER2	TIM1 capture/compare enable register 2	0x00
0x00 525E		TIM1_CNTRH	TIM1 counter high	0x00
0x00 525F		TIM1_CNTRL	TIM1 counter low	0x00
0x00 5260		TIM1_PSCRH	TIM1 prescaler register high	0x00
0x00 5261		TIM1_PSCRL	TIM1 prescaler register low	0x00
0x00 5262		TIM1_ARRH	TIM1 auto-reload register high	0xFF
0x00 5263		TIM1_ARRL	TIM1 auto-reload register low	0xFF
0x00 5264		TIM1_RCR	TIM1 repetition counter register	0x00
0x00 5265		TIM1_CCR1H	TIM1 capture/compare register 1 high	0x00
0x00 5266		TIM1_CCR1L	TIM1 capture/compare register 1 low	0x00
0x00 5267		TIM1_CCR2H	TIM1 capture/compare register 2 high	0x00
0x00 5268		TIM1_CCR2L	TIM1 capture/compare register 2 low	0x00
0x00 5269		TIM1_CCR3H	TIM1 capture/compare register 3 high	0x00
0x00 526A		TIM1_CCR3L	TIM1 capture/compare register 3 low	0x00
0x00 526B		TIM1_CCR4H	TIM1 capture/compare register 4 high	0x00
0x00 526C		TIM1_CCR4L	TIM1 capture/compare register 4 low	0x00
0x00 526D		TIM1_BKR	TIM1 break register	0x00
0x00 526E		TIM1_DTR	TIM1 dead-time register	0x00
0x00 526F		TIM1_OISR	TIM1 output idle state register	0x00
0x00 5270 to 0x00 52FF	Reserved area (147 bytes)			

Table 9. General hardware register map (continued)

Address	Block	Register label	Register name	Reset status
0x00 5300	TIM2	TIM2_CR1	TIM2 control register 1	0x00
0x00 5301		TIM2_IER	TIM2 interrupt enable register	0x00
0x00 5302		TIM2_SR1	TIM2 status register 1	0x00
0x00 5303		TIM2_SR2	TIM2 status register 2	0x00
0x00 5304		TIM2_EGR	TIM2 event generation register	0x00
0x00 5305		TIM2_CCMR1	TIM2 capture/compare mode register 1	0x00
0x00 5306		TIM2_CCMR2	TIM2 capture/compare mode register 2	0x00
0x00 5307		TIM2_CCMR3	TIM2 capture/compare mode register 3	0x00
0x00 5308		TIM2_CCER1	TIM2 capture/compare enable register 1	0x00
0x00 5309		TIM2_CCER2	TIM2 capture/compare enable register 2	0x00
0x00 530A		TIM2_CNTRH	TIM2 counter high	0x00
0x00 530B		TIM2_CNTRL	TIM2 counter low	0x00
00 530C0x		TIM2_PSCR	TIM2 prescaler register	0x00
0x00 530D		TIM2_ARRH	TIM2 auto-reload register high	0xFF
0x00 530E		TIM2_ARRL	TIM2 auto-reload register low	0xFF
0x00 530F		TIM2_CCR1H	TIM2 capture/compare register 1 high	0x00
0x00 5310		TIM2_CCR1L	TIM2 capture/compare register 1 low	0x00
0x00 5311		TIM2_CCR2H	TIM2 capture/compare reg. 2 high	0x00
0x00 5312		TIM2_CCR2L	TIM2 capture/compare register 2 low	0x00
0x00 5313		TIM2_CCR3H	TIM2 capture/compare register 3 high	0x00
0x00 5314	TIM2_CCR3L	TIM2 capture/compare register 3 low	0x00	
0x00 5315 to 0x00 531F	Reserved area (11 bytes)			

Table 9. General hardware register map (continued)

Address	Block	Register label	Register name	Reset status
0x00 5320	TIM3	TIM3_CR1	TIM3 control register 1	0x00
0x00 5321		TIM3_IER	TIM3 interrupt enable register	0x00
0x00 5322		TIM3_SR1	TIM3 status register 1	0x00
0x00 5323		TIM3_SR2	TIM3 status register 2	0x00
0x00 5324		TIM3_EGR	TIM3 event generation register	0x00
0x00 5325		TIM3_CCMR1	TIM3 capture/compare mode register 1	0x00
0x00 5326		TIM3_CCMR2	TIM3 capture/compare mode register 2	0x00
0x00 5327		TIM3_CCER1	TIM3 capture/compare enable register 1	0x00
0x00 5328		TIM3_CNTRH	TIM3 counter high	0x00
0x00 5329		TIM3_CNTRL	TIM3 counter low	0x00
0x00 532A		TIM3_PSCR	TIM3 prescaler register	0x00
0x00 532B		TIM3_ARRH	TIM3 auto-reload register high	0xFF
0x00 532C		TIM3_ARRL	TIM3 auto-reload register low	0xFF
0x00 532D		TIM3_CCR1H	TIM3 capture/compare register 1 high	0x00
0x00 532E		TIM3_CCR1L	TIM3 capture/compare register 1 low	0x00
0x00 532F		TIM3_CCR2H	TIM3 capture/compare register 2 high	0x00
0x00 5330		TIM3_CCR2L	TIM3 capture/compare register 2 low	0x00
0x00 5331 to 0x00 533F		Reserved area (15 bytes)		
0x00 5340	TIM4	TIM4_CR1	TIM4 control register 1	0x00
0x00 5341		TIM4_IER	TIM4 interrupt enable register	0x00
0x00 5342		TIM4_SR	TIM4 status register	0x00
0x00 5343		TIM4_EGR	TIM4 event generation register	0x00
0x00 5344		TIM4_CNTR	TIM4 counter	0x00
0x00 5345		TIM4_PSCR	TIM4 prescaler register	0x00
0x00 5346		TIM4_ARR	TIM4 auto-reload register	0xFF
0x00 5347 to 0x00 53FF	Reserved area (185 bytes)			

Table 9. General hardware register map (continued)

Address	Block	Register label	Register name	Reset status
0x00 5400	ADC2	ADC_CSR	ADC control/status register	0x00
0x00 5401		ADC_CR1	ADC configuration register 1	0x00
0x00 5402		ADC_CR2	ADC configuration register 2	0x00
0x00 5403		ADC_CR3	ADC configuration register 3	0x00
0x00 5404		ADC_DRH	ADC data register high	undefined
0x00 5405		ADC_DRL	ADC data register low	undefined
0x00 5406		ADC_TDRH	ADC Schmitt trigger disable register high	0x00
0x00 5407		ADC_TDRL	ADC Schmitt trigger disable register low	0x00
0x00 5408 to 0x00 541F	Reserved area (24 bytes)			
0x00 5420	beCAN	CAN_MCR	CAN master control register	0x02
0x00 5421		CAN_MSR	CAN master status register	0x02
0x00 5422		CAN_TSR	CAN transmit status register	0x00
0x00 5423		CAN_TPR	CAN transmit priority register	0x0C
0x00 5424		CAN_RFR	CAN receive FIFO register	0x00
0x00 5425		CAN_IER	CAN interrupt enable register	0x00
0x00 5426		CAN_DGR	CAN diagnosis register	0x0C
0x00 5427		CAN_FPSR	CAN page selection register	0x00
0x00 5428		CAN_P0	CAN paged register 0	
0x00 5429		CAN_P1	CAN paged register 1	
0x00 542A		CAN_P2	CAN paged register 2	
0x00 542B		CAN_P3	CAN paged register 3	
0x00 542C		CAN_P4	CAN paged register 4	
0x00 542D		CAN_P5	CAN paged register 5	
0x00 542E		CAN_P6	CAN paged register 6	
0x00 542F		CAN_P7	CAN paged register 7	
0x00 5430		CAN_P8	CAN paged register 8	
0x00 5431		CAN_P9	CAN paged register 9	
0x00 5432		CAN_PA	CAN paged register A	
0x00 5433		CAN_PB	CAN paged register B	
0x00 5434	CAN_PC	CAN paged register C		
0x00 5435	CAN_PD	CAN paged register D		
0x00 5436	CAN_PE	CAN paged register E		

Table 9. General hardware register map (continued)

Address	Block	Register label	Register name	Reset status
0x00 5437	beCAN cont'd	CAN_PF	CAN paged register F	
0x00 5438 to 0x00 57FF	Reserved area (968 bytes)			

Table 10. CPU/SWIM/debug module/interrupt controller registers

Address	Block	Register Label	Register Name	Reset Status
0x00 7F00	CPU ⁽¹⁾	A	Accumulator	0x00
0x00 7F01		PCE	Program counter extended	0x00
0x00 7F02		PCH	Program counter high	0x00
0x00 7F03		PCL	Program counter low	0x00
0x00 7F04		XH	X index register high	0x00
0x00 7F05		XL	X index register low	0x00
0x00 7F06		YH	Y index register high	0x00
0x00 7F07		YL	Y index register low	0x00
0x00 7F08		SPH	Stack pointer high	0x17 ⁽²⁾
0x00 7F09		SPL	Stack pointer low	0xFF
0x00 7F0A		CCR	Condition code register	0x28
0x00 7F0B to 0x00 7F5F		Reserved area (85 bytes)		
0x00 7F60	CPU	CFG_GCR	Global configuration register	0x00
0x00 7F70	ITC	ITC_SPR1	Interrupt software priority register 1	0xFF
0x00 7F71		ITC_SPR2	Interrupt software priority register 2	0xFF
0x00 7F72		ITC_SPR3	Interrupt software priority register 3	0xFF
0x00 7F73		ITC_SPR4	Interrupt software priority register 4	0xFF
0x00 7F74		ITC_SPR5	Interrupt software priority register 5	0xFF
0x00 7F75		ITC_SPR6	Interrupt software priority register 6	0xFF
0x00 7F76		ITC_SPR7	Interrupt software priority register 7	0xFF
0x00 7F77		ITC_SPR8	Interrupt software priority register 8	0xFF
0x00 7F78 to 0x00 7F79	Reserved area (2 bytes)			
0x00 7F80	SWIM	SWIM_CSR	SWIM control status register	0x00
0x00 7F81 to 0x00 7F8F	Reserved area (15 bytes)			

Table 10. CPU/SWIM/debug module/interrupt controller registers (continued)

Address	Block	Register Label	Register Name	Reset Status
0x00 7F90	DM	DM_BK1RE	DM breakpoint 1 register extended byte	0xFF
0x00 7F91		DM_BK1RH	DM breakpoint 1 register high byte	0xFF
0x00 7F92		DM_BK1RL	DM breakpoint 1 register low byte	0xFF
0x00 7F93		DM_BK2RE	DM breakpoint 2 register extended byte	0xFF
0x00 7F94		DM_BK2RH	DM breakpoint 2 register high byte	0xFF
0x00 7F95		DM_BK2RL	DM breakpoint 2 register low byte	0xFF
0x00 7F96		DM_CR1	DM debug module control register 1	0x00
0x00 7F97		DM_CR2	DM debug module control register 2	0x00
0x00 7F98		DM_CSR1	DM debug module control/status register 1	0x10
0x00 7F99		DM_CSR2	DM debug module control/status register 2	0x00
0x00 7F9A		DM_ENFCTR	DM enable function register	0xFF
0x00 7F9B to 0x00 7F9F		Reserved area (5 bytes)		

1. Accessible by debug module only
2. Product dependent value, see [Figure 8: Memory map](#).

7 Interrupt vector mapping

Table 11. Interrupt mapping

IRQ no.	Source block	Description	Wakeup from halt mode	Wakeup from active-halt mode	Vector address
	RESET	Reset	Yes	Yes	0x00 8000
	TRAP	Software interrupt	-	-	0x00 8004
0	TLI	External top level interrupt	-	-	0x00 8008
1	AWU	Auto wake up from halt	-	Yes	0x00 800C
2	CLK	Clock controller	-	-	0x00 8010
3	EXTI0	Port A external interrupts	Yes ⁽¹⁾	Yes ⁽¹⁾	0x00 8014
4	EXTI1	Port B external interrupts	Yes	Yes	0x00 8018
5	EXTI2	Port C external interrupts	Yes	Yes	0x00 801C
6	EXTI3	Port D external interrupts	Yes	Yes	0x00 8020
7	EXTI4	Port E external interrupts	Yes	Yes	0x00 8024
8	beCAN	beCAN RX interrupt	Yes	Yes	0x00 8028
9	beCAN	beCAN TX/ER/SC interrupt	-	-	0x00 802C
10	SPI	End of transfer	Yes	Yes	0x00 8030
11	TIM1	TIM1 update/overflow/underflow/ trigger/break	-	-	0x00 8034
12	TIM1	TIM1 capture/compare	-	-	0x00 8038
13	TIM2	TIM2 update /overflow	-	-	0x00 803C
14	TIM2	TIM2 capture/compare	-	-	0x00 8040
15	TIM3	Update/overflow	-	-	0x00 8044
16	TIM3	Capture/compare	-	-	0x00 8048
17	UART1	Tx complete	-	-	0x00 804C
18	UART1	Receive register DATA FULL	-	-	0x00 8050
19	I ² C	I ² C interrupt	Yes	Yes	0x00 8054
20	UART3	Tx complete	-	-	0x00 8058
21	UART3	Receive register DATA FULL	-	-	0x00 805C
22	ADC2	ADC2 end of conversion	-	-	0x00 8060
23	TIM4	TIM4 update/overflow	-	-	0x00 8064
24	Flash	EOP/WR_PG_DIS	-	-	0x00 8068
Reserved					0x00 806C to 0x00 807C

1. Except PA1

8 Option bytes

Option bytes contain configurations for device hardware features as well as the memory protection of the device. They are stored in a dedicated block of the memory. Except for the ROP (read-out protection) byte, each option byte has to be stored twice, in a regular form (OPTx) and a complemented one (NOPTx) for redundancy.

Option bytes can be modified in ICP mode (via SWIM) by accessing the EEPROM address shown in [Table 12: Option bytes](#) below. Option bytes can also be modified 'on the fly' by the application in IAP mode, except the ROP option that can only be modified in ICP mode (via SWIM).

Refer to the STM8S Flash programming manual (PM0051) and STM8 SWIM communication protocol and debug module user manual (UM0470) for information on SWIM programming procedures.

Table 12. Option bytes

Addr.	Option name	Option byte no.	Option bits								Factory default setting
			7	6	5	4	3	2	1	0	
4800h	Read-out protection (ROP)	OPT0	ROP[7:0]								00h
4801h	User boot code(UBC)	OPT1	UBC[7:0]								00h
4802h		NOPT1	NUBC[7:0]								FFh
4803h	Alternate function remapping (AFR)	OPT2	AFR7	AFR6	AFR5	AFR4	AFR3	AFR2	AFR1	AFR0	00h
4804h		NOPT2	NAFR7	NAFR6	NAFR5	NAFR4	NAFR3	NAFR2	NAFR1	NAFR0	FFh
4805h	Watchdog option	OPT3	Reserved				LSI _EN	IWDG _HW	WWDG _HW	WWDG _HALT	00h
4806h		NOPT3	Reserved				NLSI _EN	NIWDG _HW	NWWDG _HW	NWWDG _HALT	FFh
4807h	Clock option	OPT4	Reserved				EXT CLK	CKAWU SEL	PRS C1	PRS C0	00h
4808h		NOPT4	Reserved				NEXT CLK	NCKAWU SEL	NPR SC1	NPR SC0	FFh
4809h	HSE clock startup	OPT5	HSECNT[7:0]								00h
480Ah		NOPT5	NHSECNT[7:0]								FFh
480Bh	Reserved	OPT6	Reserved								00h
480Ch		NOPT6	Reserved								FFh
480Dh	Flash wait states	OPT7	Reserved							Wait state	00h
480Eh		NOPT7	Reserved							Nwait state	FFh
487Eh	Bootloader	OPTBL	BL[7:0]								00h
487Fh		NOPTBL	NBL[7:0]								FFh

Table 13. Option byte description

Option byte no.	Description
OPT0	<p>ROP[7:0] Memory readout protection (ROP) 0xAA: Enable readout protection (write access via SWIM protocol) <i>Note: Refer to the family reference manual (RM0016) section on Flash/EEPROM memory readout protection for details.</i></p>
OPT1	<p>UBC[7:0] User boot code area 0x00: no UBC, no write-protection 0x01: Pages 0 to 1 defined as UBC, memory write-protected 0x02: Pages 0 to 3 defined as UBC, memory write-protected 0x03: Pages 0 to 4 defined as UBC, memory write-protected ... 0xFE: Pages 0 to 255 defined as UBC, memory write-protected 0xFF: Reserved <i>Note: Refer to the family reference manual (RM0016) section on Flash/EEPROM write protection for more details.</i></p>
OPT2	<p>AFR7 Alternate function remapping option 7 0: Port D4 alternate function = TIM2_CH1 1: Port D4 alternate function = BEEP</p> <p>AFR6 Alternate function remapping option 6 0: Port B5 alternate function = AIN5, port B4 alternate function = AIN4 1: Port B5 alternate function = I²C_SDA, port B4 alternate function = I²C_SCL</p> <p>AFR5 Alternate function remapping option 5 0: Port B3 alternate function = AIN3, port B2 alternate function = AIN2, port B1 alternate function = AIN1, port B0 alternate function = AIN0 1: Port B3 alternate function = TIM1_ETR, port B2 alternate function = TIM1_CH3N, port B1 alternate function = TIM1_CH2N, port B0 alternate function = TIM1_CH1N</p> <p>AFR4 Alternate function remapping option 4 0: Port D7 alternate function = TLI 1: Port D7 alternate function = TIM1_CH4</p> <p>AFR3 Alternate function remapping option 3 0: Port D0 alternate function = TIM3_CH2 1: Port D0 alternate function = TIM1_BKIN</p> <p>AFR2 Alternate function remapping option 2 0: Port D0 alternate function = TIM3_CH2 1: Port D0 alternate function = CLK_CCO <i>Note: AFR2 option has priority over AFR3 if both are activated</i></p> <p>AFR1 Alternate function remapping option 1 0: Port A3 alternate function = TIM2_CH3, port D2 alternate function = TIM3_CH1 1: Port A3 alternate function = TIM3_CH1, port D2 alternate function = TIM2_CH3</p> <p>AFR0 Alternate function remapping option 0 0: Port D3 alternate function = TIM2_CH2 1: Port D3 alternate function = ADC_ETR</p>

Table 13. Option byte description (continued)

Option byte no.	Description
OPT3	LSI_EN: <i>Low speed internal clock enable</i> 0: LSI clock is not available as CPU clock source 1: LSI clock is available as CPU clock source
	IWDG_HW: <i>Independent watchdog</i> 0: IWDG Independent watchdog activated by software 1: IWDG Independent watchdog activated by hardware
	WWDG_HW: <i>Window watchdog activation</i> 0: WWDG window watchdog activated by software 1: WWDG window watchdog activated by hardware
	WWDG_HALT: <i>Window watchdog reset on halt</i> 0: No reset generated on halt if WWDG active 1: Reset generated on halt if WWDG active
OPT4	EXTCLK: <i>External clock selection</i> 0: External crystal connected to OSCIN/OSCOU 1: External clock signal on OSCIN
	CKAWUSEL: <i>Auto wakeup unit/clock</i> 0: LSI clock source selected for AWU 1: HSE clock with prescaler selected as clock source for for AWU
	PRSC[1:0] AWU clock prescaler 00: 24 MHz to 128 kHz prescaler 01: 16 MHz to 128 kHz prescaler 10: 8 MHz to 128 kHz prescaler 11: 4 MHz to 128 kHz prescaler
OPT5	HSECNT[7:0]: <i>HSE crystal oscillator stabilization time</i> This configures the stabilisation time. 0x00: 2048 HSE cycles 0xB4: 128 HSE cycles 0xD2: 8 HSE cycles 0xE1: 0.5 HSE cycles
OPT6	Reserved
OPT7	WAITSTATE <i>Wait state configuration</i> This option configures the number of wait states inserted when reading from the Flash/data EEPROM memory. 1 wait state is required if $f_{CPU} > 16$ MHz. 0: No wait state 1: 1 wait state

Table 13. Option byte description (continued)

Option byte no.	Description
OPTBL	<p>BL[7:0] <i>Bootloader option byte</i></p> <p>For STM8S products, this option is checked by the boot ROM code after reset. Depending on the content of addresses 0x487E, 0x487F, and 0x8000 (reset vector), the CPU jumps to the bootloader or to the reset vector. Refer to the UM0560 (STM8L/S bootloader manual) for more details.</p> <p>For STM8L products, the bootloader option bytes are on addresses 0XXXX and 0XXXX+1 (2 bytes). These option bytes control whether the bootloader is active or not. For more details, refer to the UM0560 (STM8L/S bootloader manual) for more details.</p>

9 Unique ID

The devices feature a 96-bit unique device identifier which provides a reference number that is unique for any device and in any context. The 96 bits of the identifier can never be altered by the user.

The unique device identifier can be read in single bytes and may then be concatenated using a custom algorithm.

The unique device identifier is ideally suited:

- For use as serial numbers
- For use as security keys to increase the code security in the program memory while using and combining this unique ID with software cryptographic primitives and protocols before programming the internal memory.
- To activate secure boot processes

Table 14. Unique ID registers (96 bits)

Address	Content description	Unique ID bits							
		7	6	5	4	3	2	1	0
0x48CD	X co-ordinate on the wafer	U_ID[7:0]							
0x48CE		U_ID[15:8]							
0x48CF	Y co-ordinate on the wafer	U_ID[23:16]							
0x48D0		U_ID[31:24]							
0x48D1	Wafer number	U_ID[39:32]							
0x48D2	Lot number	U_ID[47:40]							
0x48D3		U_ID[55:48]							
0x48D4		U_ID[63:56]							
0x48D5		U_ID[71:64]							
0x48D6		U_ID[79:72]							
0x48D7		U_ID[87:80]							
0x48D8		U_ID[95:88]							

10 Electrical characteristics

10.1 Parameter conditions

Unless otherwise specified, all voltages are referred to V_{SS} .

10.1.1 Minimum and maximum values

Unless otherwise specified the minimum and maximum values are guaranteed in the worst conditions of ambient temperature, supply voltage and frequencies by tests in production on 100 % of the devices with an ambient temperature at $T_A = 25\text{ °C}$ and $T_A = T_{Amax}$ (given by the selected temperature range).

Data based on characterization results, design simulation and/or technology characteristics are indicated in the table footnotes and are not tested in production. Based on characterization, the minimum and maximum values refer to sample tests and represent the mean value plus or minus three times the standard deviation (mean $\pm 3\sigma$).

10.1.2 Typical values

Unless otherwise specified, typical data are based on $T_A = 25\text{ °C}$, $V_{DD} = 5\text{ V}$. They are given only as design guidelines and are not tested.

Typical ADC accuracy values are determined by characterization of a batch of samples from a standard diffusion lot over the full temperature range, where 95% of the devices have an error less than or equal to the value indicated (mean $\pm 2\sigma$).

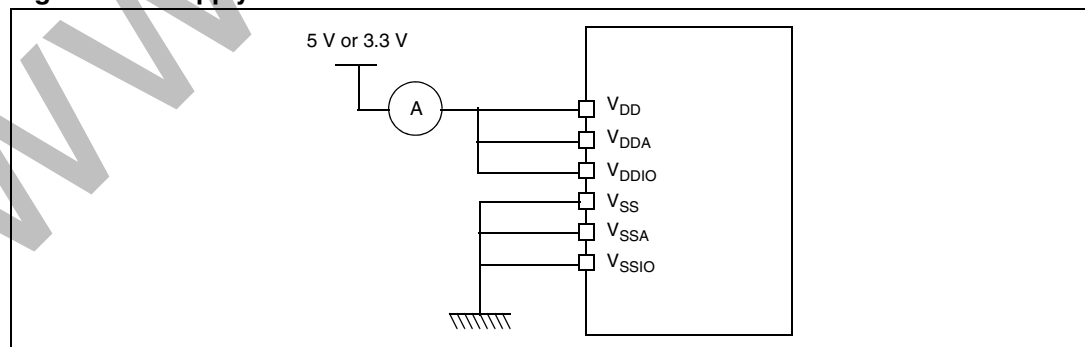
10.1.3 Typical curves

Unless otherwise specified, all typical curves are given only as design guidelines and are not tested.

10.1.4 Typical current consumption

For typical current consumption measurements, V_{DD} , V_{DDIO} and V_{DDA} are connected together in the configuration shown in [Figure 9](#).

Figure 9. Supply current measurement conditions

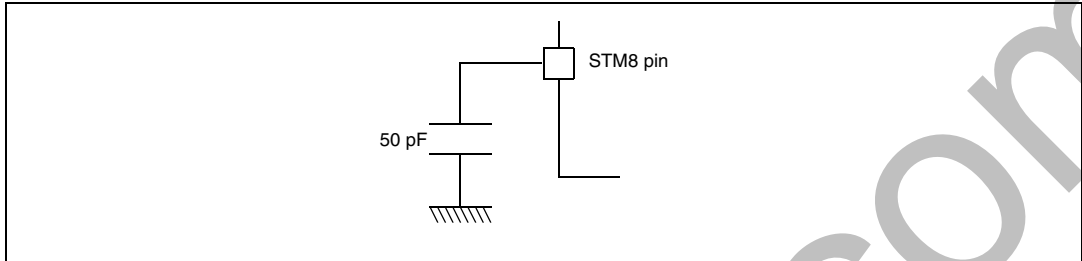


10.1.5 Pin loading conditions

10.1.6 Loading capacitor

The loading conditions used for pin parameter measurement are shown in [Figure 10](#).

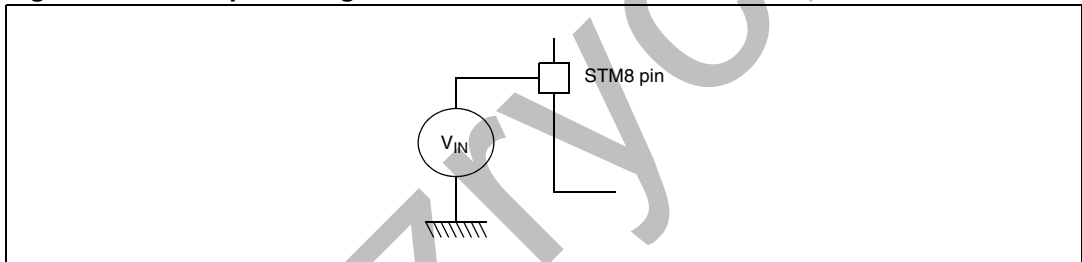
Figure 10. Pin loading conditions



10.1.7 Pin input voltage

The input voltage measurement on a pin of the device is described in [Figure 11](#).

Figure 11. Pin input voltage



10.2 Absolute maximum ratings

Stresses above those listed as 'absolute maximum ratings' may cause permanent damage to the device. This is a stress rating only and functional operation of the device under these conditions is not implied. Exposure to maximum rating conditions for extended periods may affect device reliability.

Table 15. Voltage characteristics

Symbol	Ratings	Min	Max	Unit
$V_{DDx} - V_{SS}$	Supply voltage (including V_{DDA} and V_{DDIO}) ⁽¹⁾	-0.3	6.5	V
V_{IN}	Input voltage on true open drain pins (PE1, PE2) ⁽²⁾	$V_{SS} - 0.3$	6.5	
	Input voltage on any other pin ⁽²⁾	$V_{SS} - 0.3$	$V_{DD} + 0.3$	
$ V_{DDx} - V_{DD} $	Variations between different power pins		50	mV
$ V_{SSx} - V_{SS} $	Variations between all the different ground pins		50	
V_{ESD}	Electrostatic discharge voltage	see Absolute maximum ratings (electrical sensitivity) on page 87		

1. All power (V_{DD} , V_{DDIO} , V_{DDA}) and ground (V_{SS} , V_{SSIO} , V_{SSA}) pins must always be connected to the external power supply
2. $I_{INJ(PIN)}$ must never be exceeded. This is implicitly insured if V_{IN} maximum is respected. If V_{IN} maximum cannot be respected, the injection current must be limited externally to the $I_{INJ(PIN)}$ value. A positive injection is induced by $V_{IN} > V_{DD}$ while a negative injection is induced by $V_{IN} < V_{SS}$. For true open-drain pads, there is no positive injection current, and the corresponding V_{IN} maximum must always be respected

Table 16. Current characteristics

Symbol	Ratings	Max. ⁽¹⁾	Unit
I_{VDD}	Total current into V_{DD} power lines (source) ⁽²⁾	60	mA
I_{VSS}	Total current out of V_{SS} ground lines (sink) ⁽²⁾	60	
I_{IO}	Output current sunk by any I/O and control pin	20	
	Output current source by any I/Os and control pin	20	
ΣI_{IO}	Total output current sourced (sum of all I/O and control pins) for devices with two V_{DDIO} pins ⁽³⁾	200	
	Total output current sourced (sum of all I/O and control pins) for devices with one V_{DDIO} pin ⁽³⁾	100	
	Total output current sunk (sum of all I/O and control pins) for devices with two V_{SSIO} pins ⁽³⁾	160	
	Total output current sunk (sum of all I/O and control pins) for devices with one V_{SSIO} pin ⁽³⁾	80	
$I_{INJ(PIN)}$ ⁽⁴⁾⁽⁵⁾	Injected current on NRST pin	±4	
	Injected current on OSCIN pin	±4	
	Injected current on any other pin ⁽⁶⁾	±4	
$\Sigma I_{INJ(PIN)}$ ⁽⁴⁾	Total injected current (sum of all I/O and control pins) ⁽⁶⁾	±20	

1. Data based on characterization results, not tested in production.
2. All power (V_{DD} , V_{DDIO} , V_{DDA}) and ground (V_{SS} , V_{SSIO} , V_{SSA}) pins must always be connected to the external supply.
3. I/O pins used simultaneously for high current source/sink must be uniformly spaced around the package between the V_{DDIO}/V_{SSIO} pins.
4. $I_{INJ(PIN)}$ must never be exceeded. This is implicitly insured if V_{IN} maximum is respected. If V_{IN} maximum cannot be respected, the injection current must be limited externally to the $I_{INJ(PIN)}$ value. A positive injection is induced by $V_{IN} > V_{DD}$ while a negative injection is induced by $V_{IN} < V_{SS}$. For true open-drain pads, there is no positive injection current, and the corresponding V_{IN} maximum must always be respected.
5. Negative injection disturbs the analog performance of the device. See note in [Section 10.3.10: 10-bit ADC characteristics on page 83](#).
6. When several inputs are submitted to a current injection, the maximum $\Sigma I_{INJ(PIN)}$ is the absolute sum of the positive and negative injected currents (instantaneous values). These results are based on characterization with $\Sigma I_{INJ(PIN)}$ maximum current injection on four I/O port pins of the device.

Table 17. Thermal characteristics

Symbol	Ratings	Value	Unit
T_{STG}	Storage temperature range	-65 to 150	°C
T_J	Maximum junction temperature	150	

10.3 Operating conditions

The device must be used in operating conditions that respect the parameters in [Table 18](#). In addition, full account must be taken of all physical capacitor characteristics and tolerances.

Table 18. General operating conditions

Symbol	Parameter	Conditions	Min	Max	Unit
f _{CPU}	Internal CPU clock frequency	T _A ≤ 105 °C	0	24	MHz
			0	16	MHz
V _{DD} /V _{DD_IO}	Standard operating voltage		2.95	5.5	V
VCAP	C _{EXT} : capacitance of external capacitor ⁽¹⁾	At 1 MHz	470	3300	nF
	ESR of external capacitor ⁽¹⁾			0.3	Ohm
	ESR of external capacitor ⁽¹⁾			15	nH
P _D ⁽²⁾	Power dissipation at T _A = 85° C for suffix 6 or T _A = 125° C for suffix 3	44, 48, 64, and 80-pin devices, with output on 8 standard ports, 2 high sink ports and 2 open drain ports simultaneously ⁽³⁾		443	mW
		32-pin package, with output on 8 standard ports and 2 high sink ports simultaneously ⁽³⁾		360	
T _A	Ambient temperature for 6 suffix version	Maximum power dissipation	-40	85	°C
	Ambient temperature for 3 suffix version	Maximum power dissipation	-40	125	
T _J	Junction temperature range	6 suffix version	-40	105	
		3 suffix version	-40	130 ⁽⁴⁾	

- Care should be taken when selecting the capacitor, due to its tolerance, as well as its dependency on temperature, DC bias and frequency in addition to other factors.
- To calculate P_{Dmax}(T_A), use the formula $P_{Dmax} = (T_{Jmax} - T_A) / \Theta_{JA}$ (see [Section 11.2: Thermal characteristics on page 96](#)) with the value for T_{Jmax} given in [Table 18](#) above and the value for Θ_{JA} given in [Table 57: Thermal characteristics](#).
- Refer to [Section 11.2: Thermal characteristics on page 96](#) for the calculation method.
- T_{Jmax} is given by the test limit. Above this value the product behavior is not guaranteed.

Figure 12. f_{CPUmax} versus V_{DD}

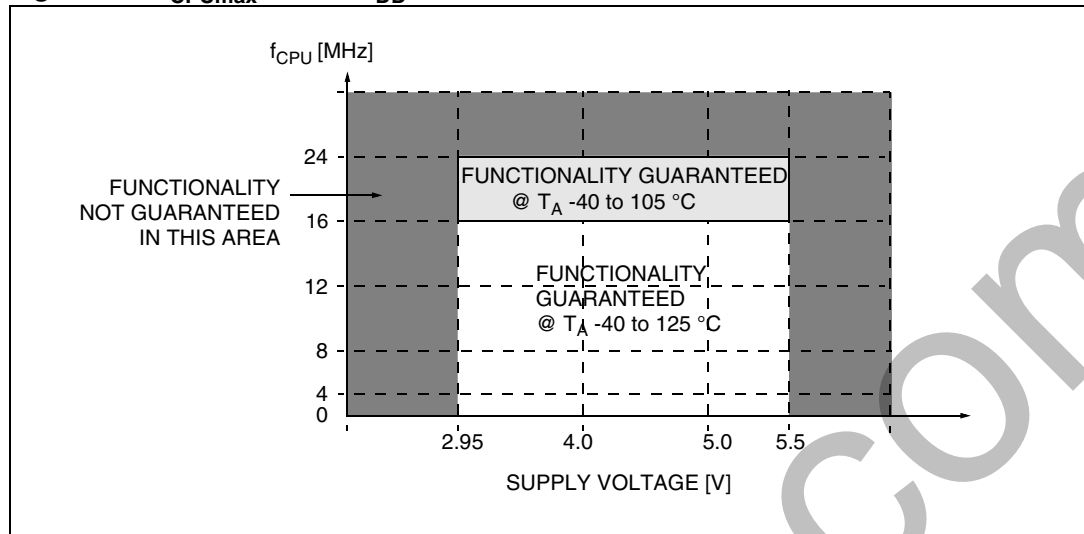


Table 19. Operating conditions at power-up/power-down

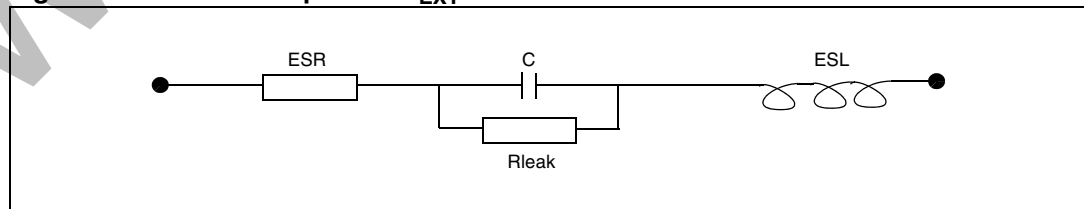
Symbol	Parameter	Conditions	Min	Typ	Max	Unit
t_{VDD}	V_{DD} rise time rate		2 ⁽¹⁾		∞	$\mu\text{s/V}$
	V_{DD} fall time rate		2 ⁽¹⁾		∞	
t_{TEMP}	Reset release delay	V_{DD} rising			1.7 ⁽¹⁾	ms
V_{IT+}	Power-on reset threshold		2.65	2.8	2.95	V
V_{IT-}	Brown-out reset threshold		2.58	2.73	2.88	V
$V_{HYS(BOR)}$	Brown-out reset hysteresis			70		mV

1. Guaranteed by design, not tested in production.

10.3.1 VCAP external capacitor

Stabilization for the main regulator is achieved connecting an external capacitor C_{EXT} to the V_{CAP} pin. C_{EXT} is specified in Table 18. Care should be taken to limit the series inductance to less than 15 nH.

Figure 13. External capacitor C_{EXT}



1. Legend: ESR is the equivalent series resistance and ESL is the equivalent inductance.

10.3.2 Supply current characteristics

The current consumption is measured as described in [Figure 9 on page 52](#).

Total current consumption in run mode

The MCU is placed under the following conditions:

- All I/O pins in input mode with a static value at V_{DD} or V_{SS} (no load)
- All peripherals are disabled (clock stopped by Peripheral Clock Gating registers) except if explicitly mentioned.
- When the MCU is clocked at 24 MHz, $T_A \leq 105^\circ\text{C}$ and the WAITSTATE option bit is set.

Subject to general operating conditions for V_{DD} and T_A .

Table 20. Total current consumption with code execution in run mode at $V_{DD} = 5\text{ V}$

Symbol	Parameter	Conditions	Typ	Max	Unit	
$I_{DD(RUN)}$	Supply current in run mode, code executed from RAM	$f_{CPU} = f_{MASTER} = 24\text{ MHz}$, $T_A \leq 105^\circ\text{C}$	HSE crystal osc. (24 MHz)	4.4		mA
			HSE user ext. clock (24 MHz)	3.7	7.3 ⁽¹⁾	
		$f_{CPU} = f_{MASTER} = 16\text{ MHz}$	HSE crystal osc. (16 MHz)	3.3		
			HSE user ext. clock (16 MHz)	2.7	5.8	
			HSI RC osc. (16 MHz)	2.5	3.4	
		$f_{CPU} = f_{MASTER}/128 = 125\text{ kHz}$	HSE user ext. clock (16 MHz)	1.2	4.1 ⁽¹⁾	
			HSI RC osc. (16 MHz)	1.0	1.3 ⁽¹⁾	
		$f_{CPU} = f_{MASTER}/128 = 15.625\text{ kHz}$	HSI RC osc. (16 MHz/8)	0.55		
	$f_{CPU} = f_{MASTER} = 128\text{ kHz}$	LSI RC osc. (128 kHz)	0.45			
	Supply current in run mode, code executed from Flash	$f_{CPU} = f_{MASTER} = 24\text{ MHz}$, $T_A \leq 105^\circ\text{C}$	HSE crystal osc. (24 MHz)	11.4		
			HSE user ext. clock (24 MHz)	10.8	18 ⁽¹⁾	
		$f_{CPU} = f_{MASTER} = 16\text{ MHz}$	HSE crystal osc. (16 MHz)	9.0		
			HSE user ext. clock (16 MHz)	8.2	15.2 ⁽¹⁾	
			HSI RC osc. (16 MHz)	8.1	13.2 ⁽¹⁾	
$f_{CPU} = f_{MASTER} = 2\text{ MHz}$.		HSI RC osc. (16 MHz/8) ⁽²⁾	1.5			
$f_{CPU} = f_{MASTER}/128 = 125\text{ kHz}$		HSI RC osc. (16 MHz)	1.1			
$f_{CPU} = f_{MASTER}/128 = 15.625\text{ kHz}$	HSI RC osc. (16 MHz/8)	0.6				
$f_{CPU} = f_{MASTER} = 128\text{ kHz}$	LSI RC osc. (128 kHz)	0.55				

1. Data based on characterization results, not tested in production.
2. Default clock configuration measured with all peripherals off.

Table 21. Total current consumption with code execution in run mode at V_{DD} = 3.3 V

Symbol	Parameter	Conditions	Typ	Max ⁽¹⁾	Unit	
I _{DD(RUN)}	Supply current in run mode, code executed from RAM	f _{CPU} = f _{MASTER} = 24 MHz, T _A ≤ 105 °C	HSE crystal osc. (24 MHz)	4.0		mA
			HSE user ext. clock (24 MHz)	3.7	7.3	
		f _{CPU} = f _{MASTER} = 16 MHz	HSE crystal osc. (16 MHz)	2.9		
			HSE user ext. clock (16 MHz)	2.7	5.8	
			HSI RC osc. (16 MHz)	2.5	3.4	
		f _{CPU} = f _{MASTER} /128 = 125 kHz	HSE user ext. clock (16 MHz)	1.2	4.1	
			HSI RC osc. (16 MHz)	1.0	1.3	
	f _{CPU} = f _{MASTER} /128 = 15.625 kHz	HSI RC osc. (16MHz/8)	0.55			
	f _{CPU} = f _{MASTER} = 128 kHz	LSI RC osc. (128 kHz)	0.45			
	Supply current in run mode, code executed from Flash	f _{CPU} = f _{MASTER} = 24 MHz, T _A ≤ 105 °C	HSE crystal osc. (24 MHz)	11.0		
			HSE user ext. clock (24 MHz)	10.8	18.0	
		f _{CPU} = f _{MASTER} = 16 MHz	HSE crystal osc. (16 MHz)	8.4		
			HSE user ext. clock (16 MHz)	8.2	15.2	
			HSI RC osc. (16 MHz)	8.1	13.2	
f _{CPU} = f _{MASTER} = 2 MHz.		HSI RC osc. (16 MHz/8) ⁽²⁾	1.5			
f _{CPU} = f _{MASTER} /128 = 125 kHz		HSI RC osc. (16 MHz)	1.1			
f _{CPU} = f _{MASTER} /128 = 15.625 kHz	HSI RC osc. (16 MHz/8)	0.6				
f _{CPU} = f _{MASTER} = 128 kHz	LSI RC osc. (128 kHz)	0.55				

1. Data based on characterization results, not tested in production.
2. Default clock configuration.

Total current consumption in wait mode

Table 22. Total current consumption in wait mode at V_{DD} = 5 V

Symbol	Parameter	Conditions	Typ	Max ⁽¹⁾	Unit	
I _{DD(WFI)}	Supply current in wait mode	f _{CPU} = f _{MASTER} = 24 MHz, T _A ≤ 105 °C	HSE crystal osc. (24 MHz)	2.4	4.7	mA
			HSE user ext. clock (24 MHz)	1.8		
		f _{CPU} = f _{MASTER} = 16 MHz	HSE crystal osc. (16 MHz)	2.0	4.4	
			HSE user ext. clock (16 MHz)	1.4		
			HSI RC osc. (16 MHz)	1.2		
		f _{CPU} = f _{MASTER} /128 = 125 kHz	HSI RC osc. (16 MHz)	1.0		
		f _{CPU} = f _{MASTER} /128 = 15.625 kHz	HSI RC osc. (16 MHz/8) ⁽²⁾	0.55		
f _{CPU} = f _{MASTER} = 128 kHz	LSI RC osc. (128 kHz)	0.5				

1. Data based on characterization results, not tested in production.
2. Default clock configuration measured with all peripherals off.

Table 23. Total current consumption in wait mode at V_{DD} = 3.3 V

Symbol	Parameter	Conditions	Typ	Max ⁽¹⁾	Unit	
I _{DD(WFI)}	Supply current in wait mode	f _{CPU} = f _{MASTER} = 24 MHz, T _A ≤ 105 °C	HSE crystal osc. (24 MHz)	2.0	4.7	mA
			HSE user ext. clock (24 MHz)	1.8		
		f _{CPU} = f _{MASTER} = 16 MHz	HSE crystal osc. (16 MHz)	1.6	4.4	
			HSE user ext. clock (16 MHz)	1.4		
			HSI RC osc. (16 MHz)	1.2		
		f _{CPU} = f _{MASTER} /128 = 125 kHz	HSI RC osc. (16 MHz)	1.0		
		f _{CPU} = f _{MASTER} /128 = 15.625 kHz	HSI RC osc. (16 MHz/8) ⁽²⁾	0.55		
f _{CPU} = f _{MASTER} /128 = 15.625 kHz	LSI RC osc. (128 kHz)	0.5				

1. Data based on characterization results, not tested in production.
2. Default clock configuration measured with all peripherals off.

Total current consumption in active halt mode

Table 24. Total current consumption in active halt mode at V_{DD} = 5 V, T_A -40 to 85° C

Symbol	Parameter	Conditions			Typ	Max ⁽¹⁾	Unit
		Main voltage regulator (MVR) ⁽²⁾	Flash mode ⁽³⁾	Clock source			
I _{DD(AH)}	Supply current in active halt mode	On	Operating mode	HSE crystal oscillator (16 MHz)	1000	260	μA
				LSI RC oscillator (128 kHz)	200		
			Powerdown mode	HSE crystal oscillator (16 MHz)	940		
				LSI RC oscillator (128 kHz)	140		
		Off	Operating mode	LSI RC oscillator (128 kHz)	68		
			Powerdown mode		11	45	

1. Data based on characterization results, not tested in production.
2. Configured by the REGAH bit in the CLK_ICKR register.
3. Configured by the AHALT bit in the FLASH_CR1 register.

Table 25. Total current consumption in active halt mode at V_{DD} = 3.3 V

Symbol	Parameter	Conditions			Typ ⁽¹⁾	Unit
		Main voltage regulator (MVR) ⁽²⁾	Flash mode ⁽³⁾	Clock source		
I _{DD(AH)}	Supply current in active halt mode	On	Operating mode	HSE crystal osc. (16 MHz)	600	μA
				LSI RC osc. (128 kHz)	200	
			Powerdown mode	HSE crystal osc. (16 MHz)	540	
				LSI RC osc. (128 kHz)	140	
		Off	Operating mode	LSI RC osc. (128 kHz)	66	
			Powerdown mode		9	

1. Data based on characterization results, not tested in production.
2. Configured by the REGAH bit in the CLK_ICKR register.
3. Configured by the AHALT bit in the FLASH_CR1 register.

Total current consumption in halt mode

Table 26. Total current consumption in halt mode at V_{DD} = 5 V, T_A -40 to 85° C

Symbol	Parameter	Conditions	Typ	Max	Unit
I _{DD(H)}	Supply current in halt mode	Flash in operating mode, HSI clock after wakeup	63.5		μA
		Flash in powerdown mode, HSI clock after wakeup	6.5	35	

Table 27. Total current consumption in halt mode at V_{DD} = 3.3 V

Symbol	Parameter	Conditions	Typ	Unit
I _{DD(H)}	Supply current in halt mode	Flash in operating mode, HSI clock after wakeup	61.5	μA
		Flash in powerdown mode, HSI clock after wakeup	4.5	

Low power mode wakeup times

Table 28. Wakeup times

Symbol	Parameter	Conditions	Typ	Max ⁽¹⁾	Unit
t _{WU(WFI)}	Wakeup time from wait mode to run mode ⁽³⁾			See note ⁽²⁾	
		f _{CPU} = f _{MASTER} = 16 MHz.	0.56		
t _{WU(AH)}	Wakeup time active halt mode to run mode ⁽³⁾	MVR voltage regulator on ⁽⁴⁾	Flash in operating mode ⁽⁵⁾	1 ⁽⁶⁾	2 ⁽⁶⁾
			Flash in powerdown mode ⁽⁵⁾	3 ⁽⁶⁾	
		MVR voltage regulator off ⁽⁴⁾	Flash in operating mode ⁽⁵⁾	48 ⁽⁶⁾	
			Flash in powerdown mode ⁽⁵⁾	50 ⁽⁶⁾	
t _{WU(H)}	Wakeup time from halt mode to run mode ⁽³⁾	Flash in operating mode ⁽⁵⁾	52		
		Flash in powerdown mode ⁽⁵⁾	54		

1. Data guaranteed by design, not tested in production.
2. $t_{WU(WFI)} = 2 \times 1/f_{master} + 7 \times 1/f_{CPU}$
3. Measured from interrupt event to interrupt vector fetch.
4. Configured by the REGAH bit in the CLK_IICKR register.
5. Configured by the AHALT bit in the FLASH_CR1 register.
6. Plus 1 LSI clock depending on synchronization.



Total current consumption and timing in forced reset state

Table 29. Total current consumption and timing in forced reset state

Symbol	Parameter	Conditions	Typ	Max ⁽¹⁾	Unit
I _{DD(R)}	Supply current in reset state	V _{DD} = 5 V	1.6		mA
		V _{DD} = 3.3 V	0.8		
t _{RESETBL}	Reset release to bootloader vector fetch			150	μs

1. Data guaranteed by design, not tested in production.

Current consumption of on-chip peripherals

Subject to general operating conditions for V_{DD} and T_A.

HSI internal RC/f_{CPU} = f_{MASTER} = 16 MHz.

Table 30. Peripheral current consumption

Symbol	Parameter	Typ.	Unit
I _{DD(TIM1)}	TIM1 supply current ⁽¹⁾	220	μA
I _{DD(TIM2)}	TIM2 supply current ⁽¹⁾	120	
I _{DD(TIM3)}	TIM3 timer supply current ⁽¹⁾	100	
I _{DD(TIM4)}	TIM4 timer supply current ⁽¹⁾	25	
I _{DD(UART1)}	UART1 supply current ⁽²⁾	90	
I _{DD(UART3)}	UART3 supply current ⁽²⁾	110	
I _{DD(SPI)}	SPI supply current ⁽²⁾	40	
I _{DD(I²C)}	I ² C supply current ⁽²⁾	50	
I _{DD(CAN)}	beCAN supply current ⁽²⁾	210	
I _{DD(ADC2)}	ADC2 supply current when converting ⁽³⁾	1000	

1. Data based on a differential I_{DD} measurement between reset configuration and timer counter running at 16 MHz. No IC/OC programmed (no I/O pads toggling). Not tested in production.

2. Data based on a differential I_{DD} measurement between the on-chip peripheral when kept under reset and not clocked and the on-chip peripheral when clocked and not kept under reset. No I/O pads toggling. Not tested in production.

3. Data based on a differential I_{DD} measurement between reset configuration and continuous A/D conversions. Not tested in production.

Current consumption curves

Figure 14 and Figure 15 show typical current consumption measured with code executing in RAM.

Figure 14. Typ. $I_{DD(RUN)}$ vs V_{DD} , HSI RC osc, $f_{CPU} = 16$ MHz

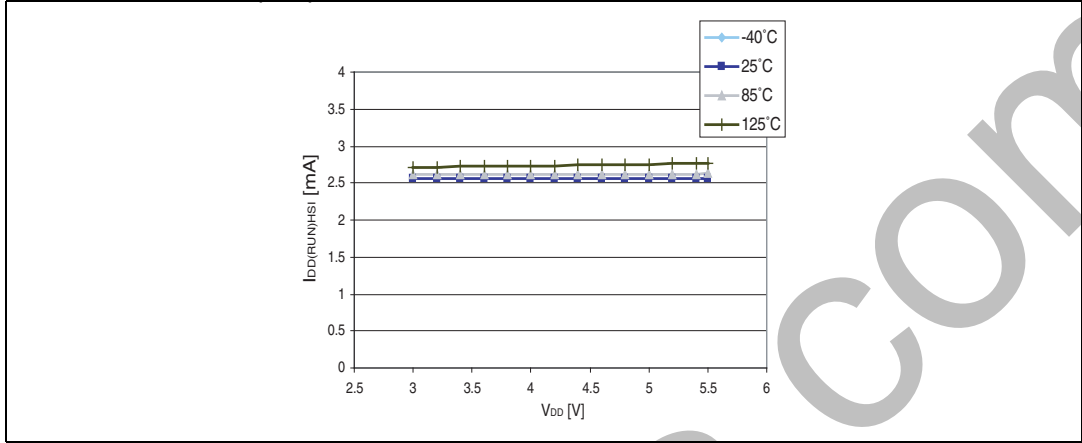
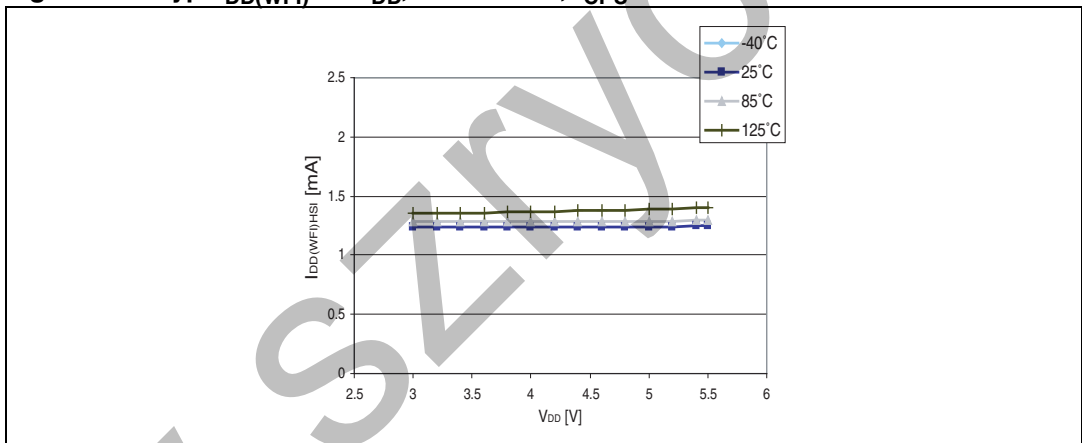


Figure 15. Typ. $I_{DD(WFI)}$ vs V_{DD} , HSI RC osc, $f_{CPU} = 16$ MHz



10.3.3 External clock sources and timing characteristics

HSE user external clock

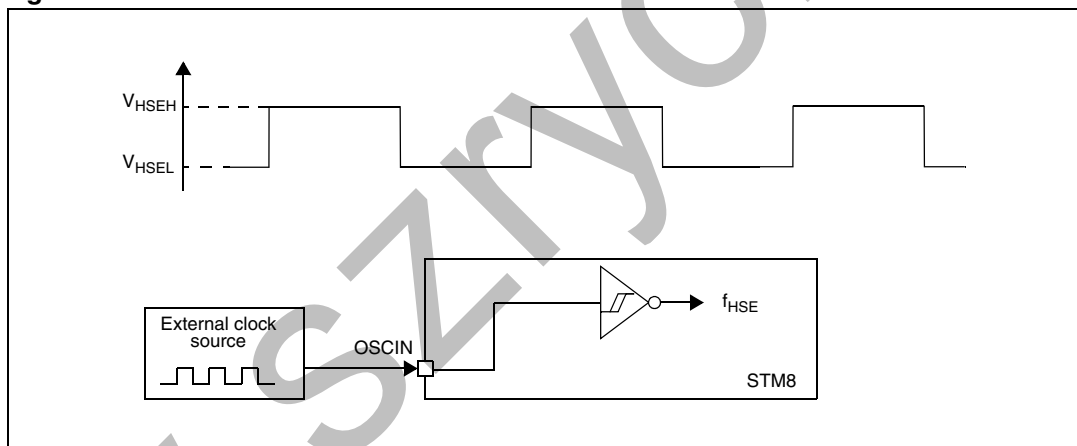
Subject to general operating conditions for V_{DD} and T_A .

Table 31. HSE user external clock characteristics

Symbol	Parameter	Conditions	Min	Typ	Max	Unit
f_{HSE_ext}	User external clock source frequency		0		24	MHz
$V_{HSEH}^{(1)}$	OSCIN input pin high level voltage		$0.7 \times V_{DD}$		$V_{DD} + 0.3 \text{ V}$	V
$V_{HSEL}^{(1)}$	OSCIN input pin low level voltage		V_{SS}		$0.3 \times V_{DD}$	
I_{LEAK_HSE}	OSCIN input leakage current	$V_{SS} < V_{IN} < V_{DD}$	-1		1	μA

1. Data based on characterization results, not tested in production.

Figure 16. HSE external clock source



HSE crystal/ceramic resonator oscillator

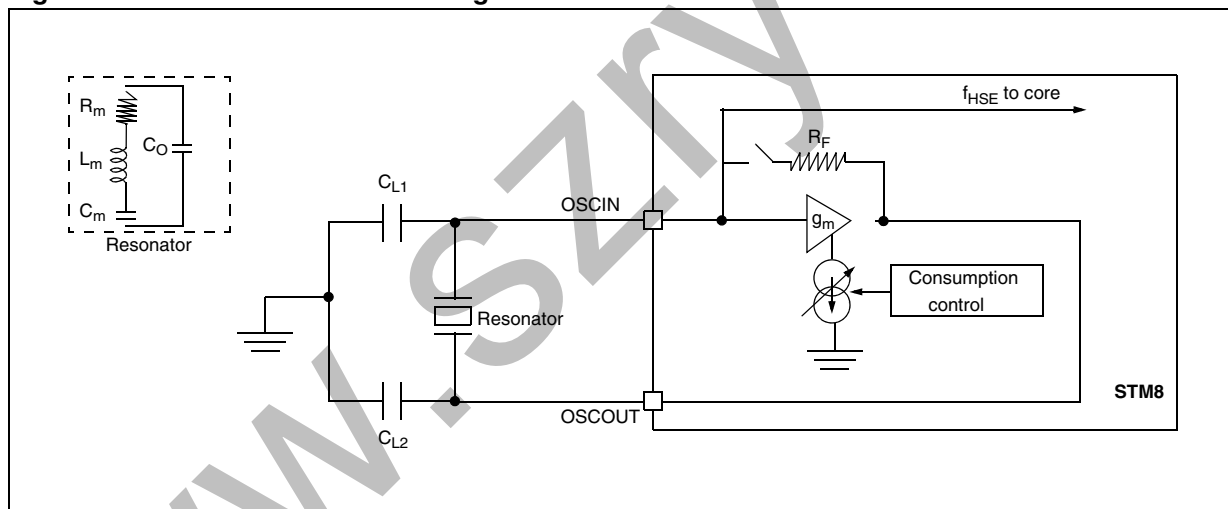
The HSE clock can be supplied with a 1 to 24 MHz crystal/ceramic resonator oscillator. All the information given in this paragraph is based on characterization results with specified typical external components. In the application, the resonator and the load capacitors have to be placed as close as possible to the oscillator pins in order to minimize output distortion and start-up stabilization time. Refer to the crystal resonator manufacturer for more details (frequency, package, accuracy...).

Table 32. HSE oscillator characteristics

Symbol	Parameter	Conditions	Min	Typ	Max	Unit
f_{HSE}	External high speed oscillator frequency		1		24	MHz
R_F	Feedback resistor			220		k Ω
$C^{(1)}$	Recommended load capacitance ⁽²⁾				20	pF
$I_{DD(HSE)}$	HSE oscillator power consumption	$C = 20$ pF, $f_{OSC} = 24$ MHz			6 (startup) 2 (stabilized) ⁽³⁾	mA
		$C = 10$ pF, $f_{OSC} = 24$ MHz			6 (startup) 1.5 (stabilized) ⁽³⁾	
g_m	Oscillator transconductance		5			mA/V
$t_{SU(HSE)}^{(4)}$	Startup time	V_{DD} is stabilized		1		ms

1. C is approximately equivalent to 2 x crystal Load.
2. The oscillator selection can be optimized in terms of supply current using a high quality resonator with small R_m value. Refer to crystal manufacturer for more details
3. Data based on characterization results, not tested in production.
4. $t_{SU(HSE)}$ is the start-up time measured from the moment it is enabled (by software) to a stabilized 24 MHz oscillation is reached. This value is measured for a standard crystal resonator and it can vary significantly with the crystal manufacturer.

Figure 17. HSE oscillator circuit diagram



HSE oscillator critical g_m formula

$$g_{m_{crit}} = (2 \times \pi \times f_{HSE})^2 \times R_m (2C_o + C)^2$$

- R_m : Notional resistance (see crystal specification)
- L_m : Notional inductance (see crystal specification)
- C_m : Notional capacitance (see crystal specification)
- C_o : Shunt capacitance (see crystal specification)
- $C_{L1}=C_{L2}=C$: Grounded external capacitance
- $g_m \gg g_{m_{crit}}$

10.3.4 Internal clock sources and timing characteristics

Subject to general operating conditions for V_{DD} and T_A . f_{HSE}

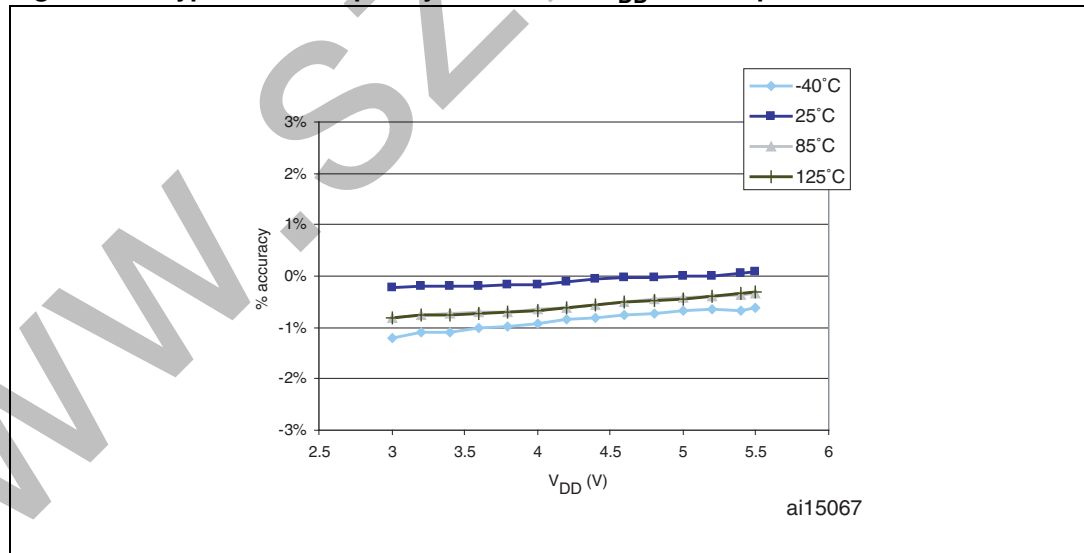
High speed internal RC oscillator (HSI)

Table 33. HSI oscillator characteristics

Symbol	Parameter	Conditions	Min	Typ	Max	Unit
f_{HSI}	Frequency			16		MHz
ACC_{HSI}	Accuracy of HSI oscillator	Trimmed by the CLK_HSITRIMR register for given V_{DD} and T_A conditions	-1 ⁽¹⁾		1 ⁽¹⁾	%
	Accuracy of HSI oscillator (factory calibrated)	$V_{DD} = 5\text{ V}, T_A = 25\text{ °C}$	-1.5		1.5	
		$V_{DD} = 5\text{ V}, 25\text{ °C} \leq T_A \leq 85\text{ °C}$	-2.2		2.2	
		$2.95\text{ V} \leq V_{DD} \leq 5.5\text{ V}, -40\text{ °C} \leq T_A \leq 125\text{ °C}$	-3 ⁽²⁾		3 ⁽²⁾	
$t_{su(HSI)}$	HSI oscillator wakeup time including calibration				1 ⁽¹⁾	μs
$I_{DD(HSI)}$	HSI oscillator power consumption			170	250 ⁽²⁾	μA

1. Guaranteed by design, not tested in production.
2. Data based on characterization results, not tested in production

Figure 18. Typical HSI frequency variation vs V_{DD} at 4 temperatures



Low speed internal RC oscillator (LSI)

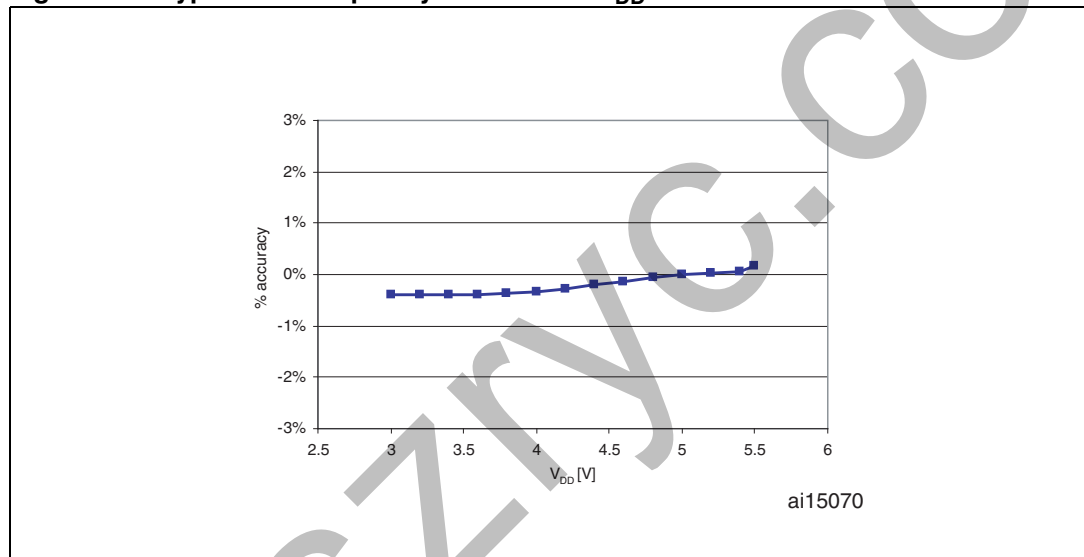
Subject to general operating conditions for V_{DD} and T_A .

Table 34. LSI oscillator characteristics

Symbol	Parameter	Conditions	Min	Typ	Max	Unit
f_{LSI}	Frequency		110	128	146	kHz
$t_{su}(LSI)$	LSI oscillator wakeup time				7 ⁽¹⁾	μs
$I_{DD}(LSI)$	LSI oscillator power consumption			5		μA

1. Guaranteed by design, not tested in production.

Figure 19. Typical LSI frequency variation vs V_{DD} @ 25 °C



10.3.5 Memory characteristics

RAM and hardware registers

Table 35. RAM and hardware registers

Symbol	Parameter	Conditions	Min	Unit
V_{RM}	Data retention mode ⁽¹⁾	Halt mode (or reset)	V_{IT-max} ⁽²⁾	V

1. Minimum supply voltage without losing data stored in RAM (in halt mode or under reset) or in hardware registers (only in halt mode). Guaranteed by design, not tested in production.

2. Refer to [Table 19 on page 57](#) for the value of V_{IT-max} .

Flash program memory/data EEPROM memory

General conditions: $T_A = -40$ to 125 °C.

Table 36. Flash program memory/data EEPROM memory

Symbol	Parameter	Conditions	Min ⁽¹⁾	Typ	Max	Unit
V_{DD}	Operating voltage (all modes, execution/write/erase)	$f_{CPU} \leq 24$ MHz	2.95		5.5	V
t_{prog}	Standard programming time (including erase) for byte/word/block (1 byte/4 bytes/128 bytes)			6	6.6	ms
	Fast programming time for 1 block (128 bytes)			3	3.3	ms
t_{erase}	Erase time for 1 block (128 bytes)			3	3.3	ms
N_{RW}	Erase/write cycles ⁽²⁾ (program memory)	$T_A = 85$ °C	10 k			cycles
	Erase/write cycles (data memory) ⁽²⁾	$T_A = 125$ °C	300 k	1M		
t_{RET}	Data retention (program memory) after 10 k erase/write cycles at $T_A = 85$ °C	$T_{RET} = 55$ °C	20			years
	Data retention (data memory) after 10 k erase/write cycles at $T_A = 85$ °C	$T_{RET} = 55$ °C	20			
	Data retention (data memory) after 300k erase/write cycles at $T_A = 125$ °C	$T_{RET} = 85$ °C	1			
I_{DD}	Supply current (Flash programming or erasing for 1 to 128 bytes)			2		mA

1. Data based on characterization results, not tested in production.

2. The physical granularity of the memory is 4 bytes, so cycling is performed on 4 bytes even when a write/erase operation addresses a single byte.

10.3.6 I/O port pin characteristics

General characteristics

Subject to general operating conditions for V_{DD} and T_A unless otherwise specified. All unused pins must be kept at a fixed voltage: using the output mode of the I/O for example or an external pull-up or pull-down resistor.

Table 37. I/O static characteristics

Symbol	Parameter	Conditions	Min	Typ	Max	Unit
V_{IL}	Input low level voltage	$V_{DD} = 5\text{ V}$	-0.3		$0.3 \times V_{DD}$	V
V_{IH}	Input high level voltage		$0.7 \times V_{DD}$		$V_{DD} + 0.3\text{ V}$	V
V_{hys}	Hysteresis ⁽¹⁾			700		mV
R_{pu}	Pull-up resistor	$V_{DD} = 5\text{ V}, V_{IN} = V_{SS}$	30	45	60	k Ω
t_R, t_F	Rise and fall time (10% - 90%)	Fast I/Os Load = 50 pF			20 ⁽²⁾	ns
		Standard and high sink I/Os Load = 50 pF			125 ⁽²⁾	ns
I_{lkg}	Input leakage current, analog and digital	$V_{SS} \leq V_{IN} \leq V_{DD}$			± 1	μA
$I_{lkg\text{ ana}}$	Analog input leakage current	$V_{SS} \leq V_{IN} \leq V_{DD}$			± 250 ⁽²⁾	nA
$I_{lkg(inj)}$	Leakage current in adjacent I/O ⁽²⁾	Injection current $\pm 4\text{ mA}$			± 1 ⁽²⁾	μA

1. Hysteresis voltage between Schmitt trigger switching levels. Based on characterization results, not tested in production.
2. Data based on characterization results, not tested in production.

Figure 20. Typical V_{IL} and V_{IH} vs V_{DD} @ 4 temperatures

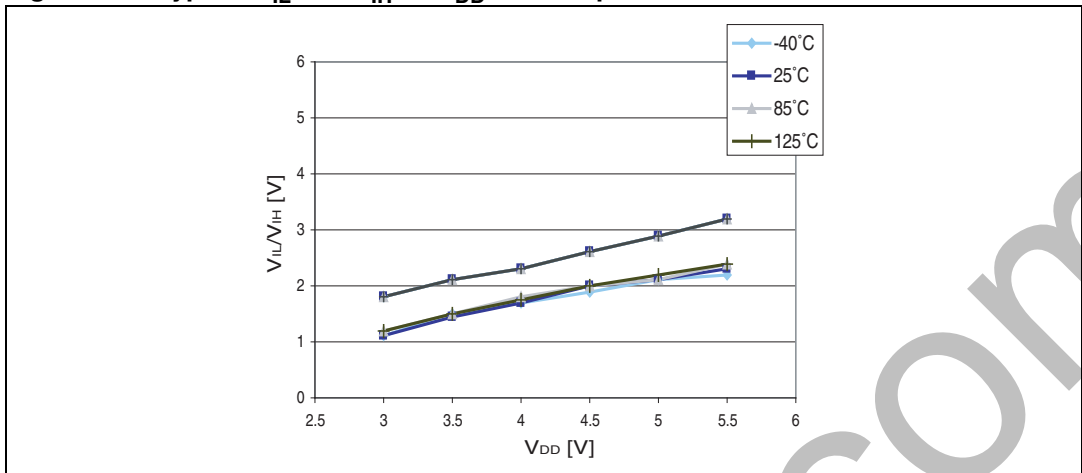


Figure 21. Typical pull-up resistance vs V_{DD} @ 4 temperatures

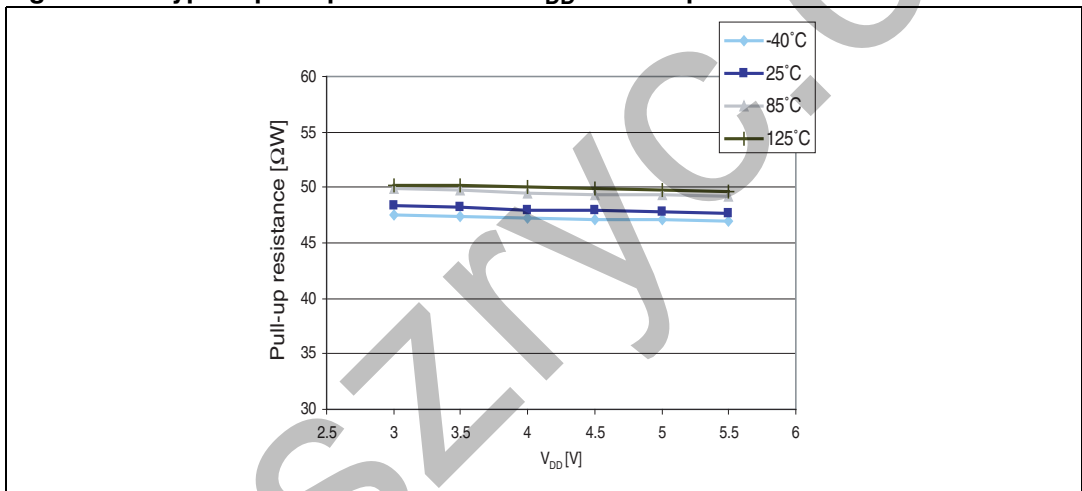
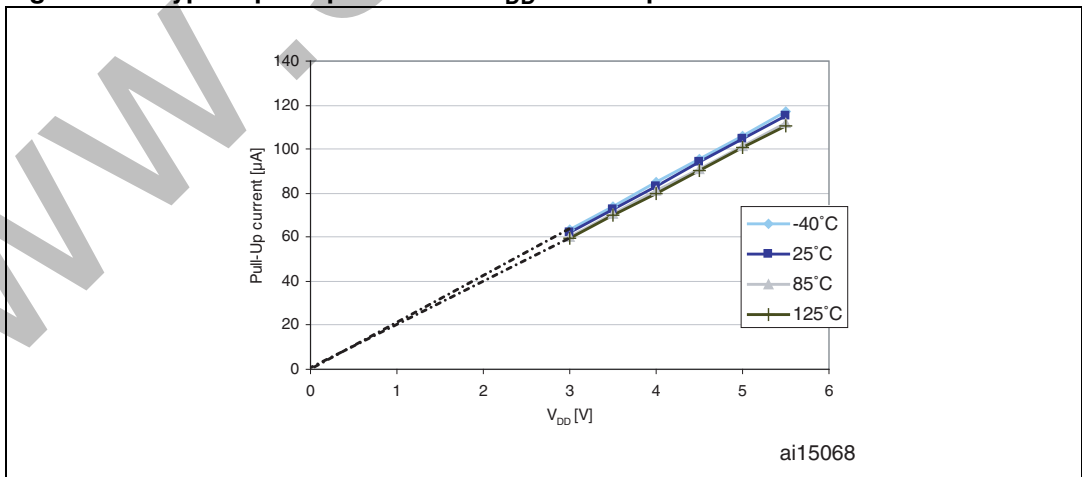


Figure 22. Typical pull-up current vs V_{DD} @ 4 temperatures



1. The pull-up is a pure resistor (slope goes through 0).

Table 38. Output driving current (standard ports)

Symbol	Parameter	Conditions	Min	Max	Unit
V_{OL}	Output low level with 8 pins sunk	$I_{IO} = 10 \text{ mA}, V_{DD} = 5 \text{ V}$		2	V
	Output low level with 4 pins sunk	$I_{IO} = 4 \text{ mA}, V_{DD} = 3.3 \text{ V}$		1 ⁽¹⁾	
V_{OH}	Output high level with 8 pins sourced	$I_{IO} = 10 \text{ mA}, V_{DD} = 5 \text{ V}$	2.8		V
	Output high level with 4 pins sourced	$I_{IO} = 4 \text{ mA}, V_{DD} = 3.3 \text{ V}$	2.1 ⁽¹⁾		

1. Data based on characterization results, not tested in production

Table 39. Output driving current (true open drain ports)

Symbol	Parameter	Conditions	Max	Unit
V_{OL}	Output low level with 2 pins sunk	$I_{IO} = 10 \text{ mA}, V_{DD} = 5 \text{ V}$	1	V
		$I_{IO} = 10 \text{ mA}, V_{DD} = 3.3 \text{ V}$	1.5 ⁽¹⁾	
		$I_{IO} = 20 \text{ mA}, V_{DD} = 5 \text{ V}$	2 ⁽¹⁾	

1. Data based on characterization results, not tested in production

Table 40. Output driving current (high sink ports)

Symbol	Parameter	Conditions	Min	Max	Unit
V_{OL}	Output low level with 8 pins sunk	$I_{IO} = 10 \text{ mA}, V_{DD} = 5 \text{ V}$		0.8	V
	Output low level with 4 pins sunk	$I_{IO} = 10 \text{ mA}, V_{DD} = 3.3 \text{ V}$		1 ⁽¹⁾	
	Output low level with 4 pins sunk	$I_{IO} = 20 \text{ mA}, V_{DD} = 5 \text{ V}$		1.5 ⁽¹⁾	
V_{OH}	Output high level with 8 pins sourced	$I_{IO} = 10 \text{ mA}, V_{DD} = 5 \text{ V}$	4.0		
	Output high level with 4 pins sourced	$I_{IO} = 10 \text{ mA}, V_{DD} = 3.3 \text{ V}$	2.1 ⁽¹⁾		
	Output high level with 4 pins sourced	$I_{IO} = 20 \text{ mA}, V_{DD} = 5 \text{ V}$	3.3 ⁽¹⁾		

1. Data based on characterization results, not tested in production

Typical output level curves

Figure 24 to Figure 31 show typical output level curves measured with output on a single pin.

Figure 23. Typ. V_{OL} @ $V_{DD} = 5\text{ V}$ (standard ports)

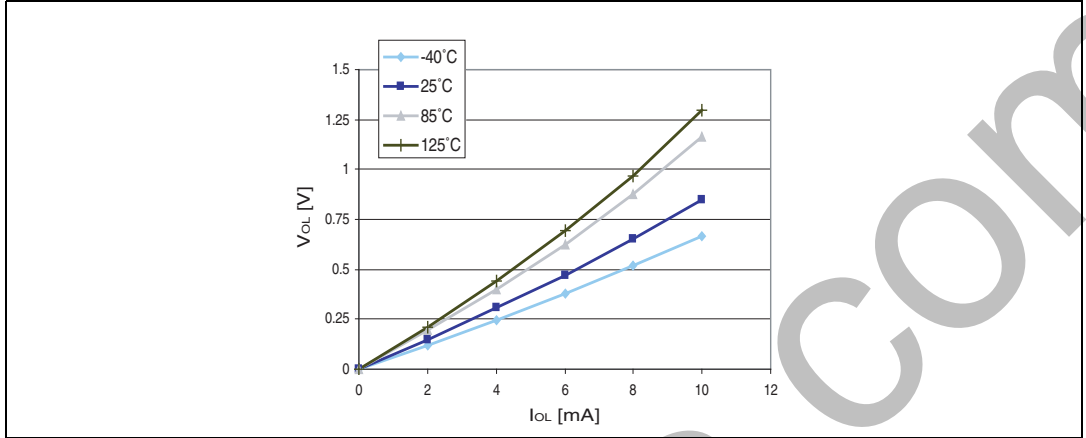


Figure 24. Typ. V_{OL} @ $V_{DD} = 3.3\text{ V}$ (standard ports)

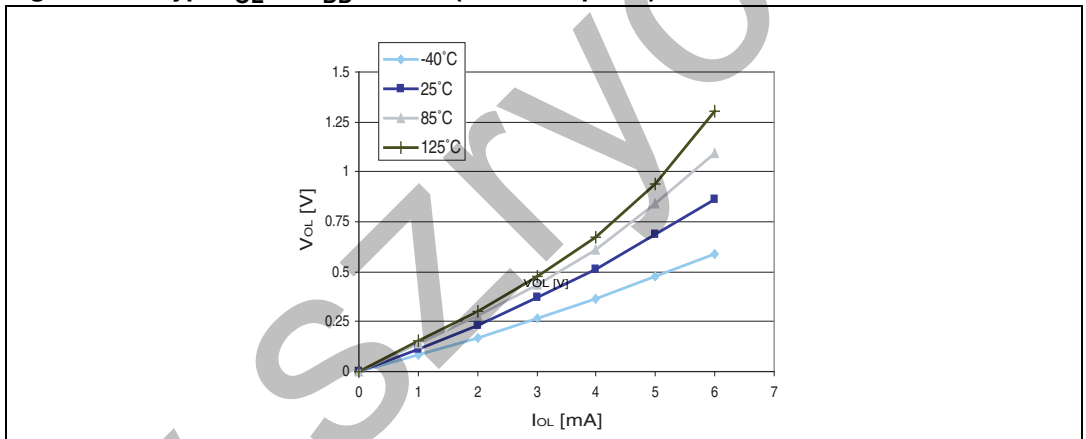


Figure 25. Typ. V_{OL} @ $V_{DD} = 5\text{ V}$ (true open drain ports)

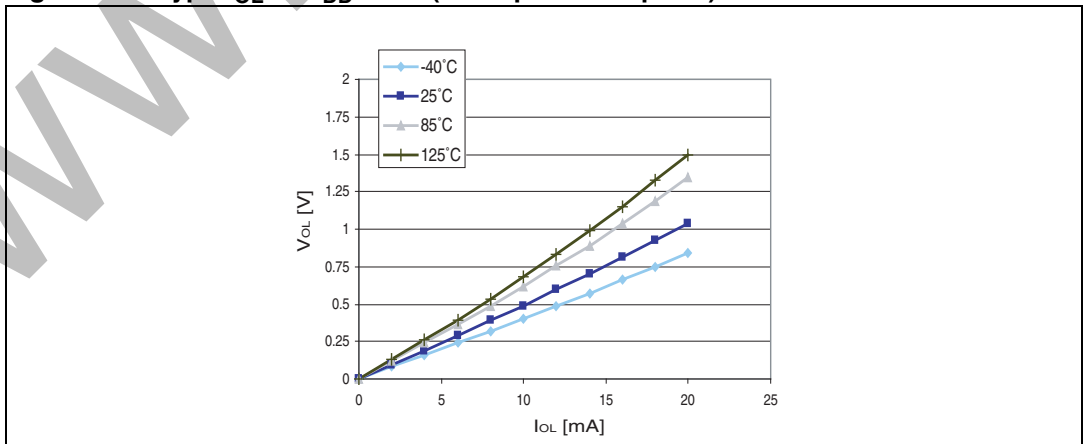


Figure 26. Typ. V_{OL} @ $V_{DD} = 3.3\text{ V}$ (true open drain ports)

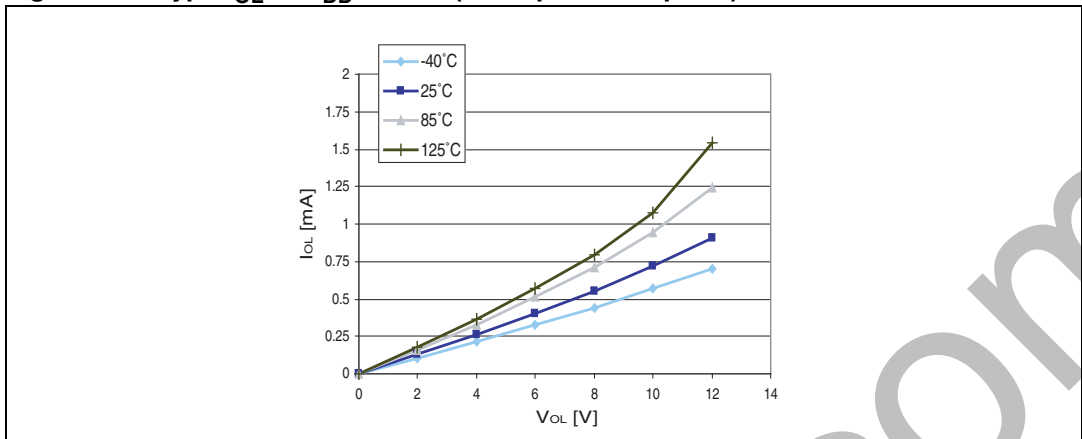


Figure 27. Typ. V_{OL} @ $V_{DD} = 5\text{ V}$ (high sink ports)

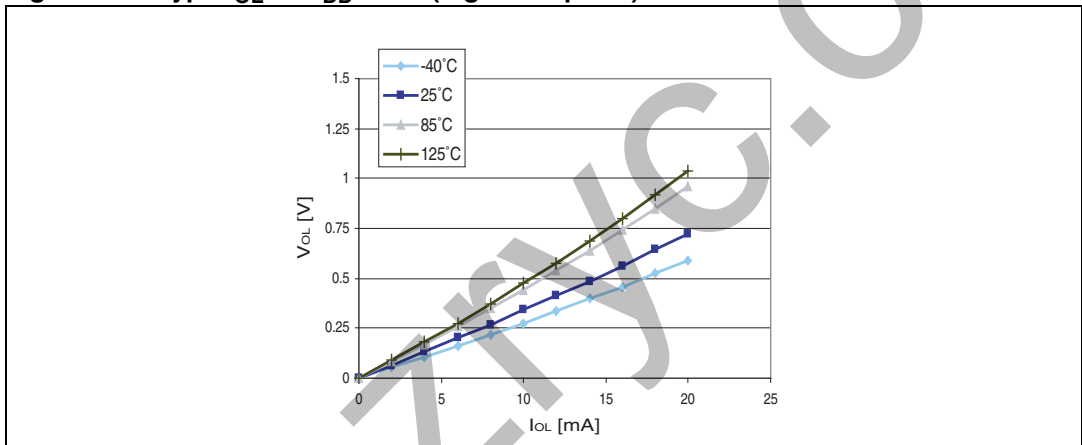


Figure 28. Typ. V_{OL} @ $V_{DD} = 3.3\text{ V}$ (high sink ports)

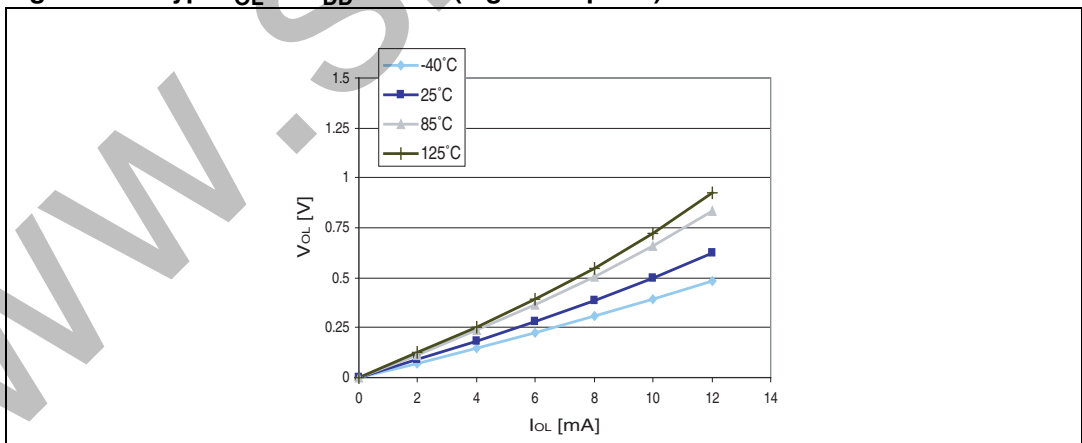


Figure 29. Typ. $V_{DD} - V_{OH}$ @ $V_{DD} = 5\text{ V}$ (standard ports)

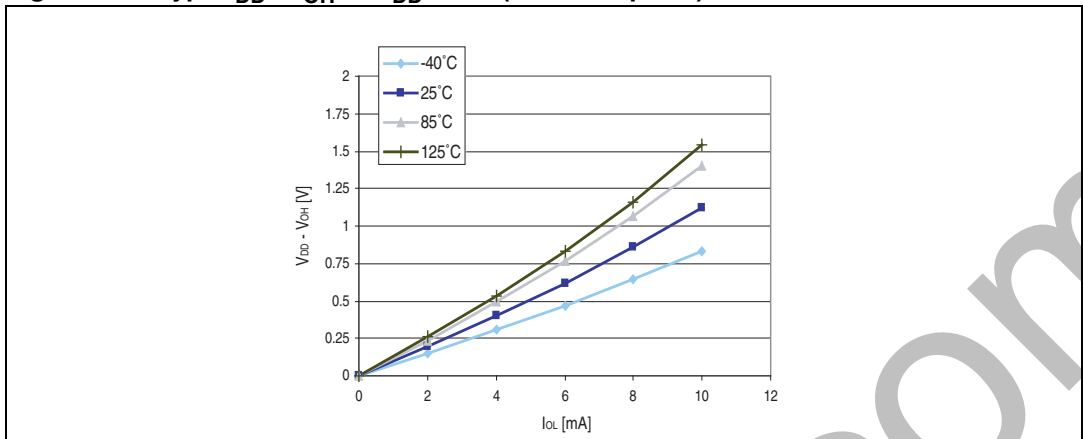


Figure 30. Typ. $V_{DD} - V_{OH}$ @ $V_{DD} = 3.3\text{ V}$ (standard ports)

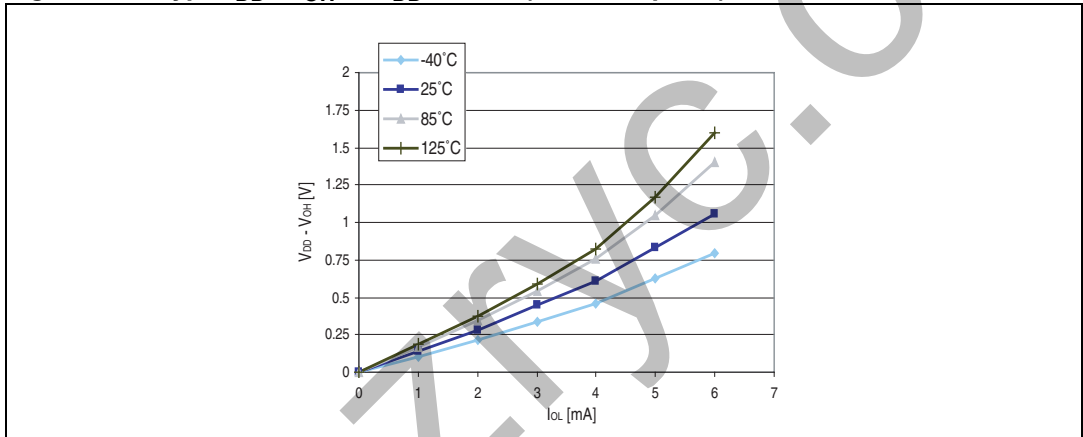


Figure 31. Typ. $V_{DD} - V_{OH}$ @ $V_{DD} = 5\text{ V}$ (high sink ports)

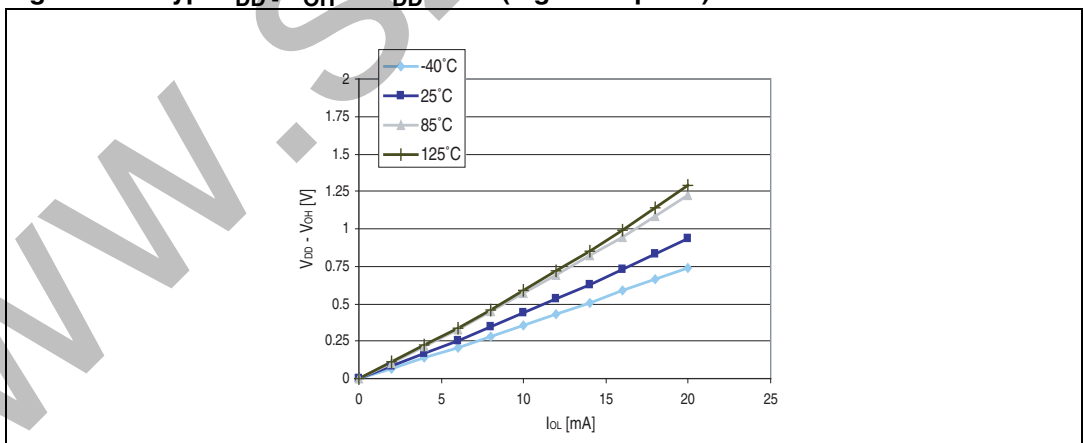
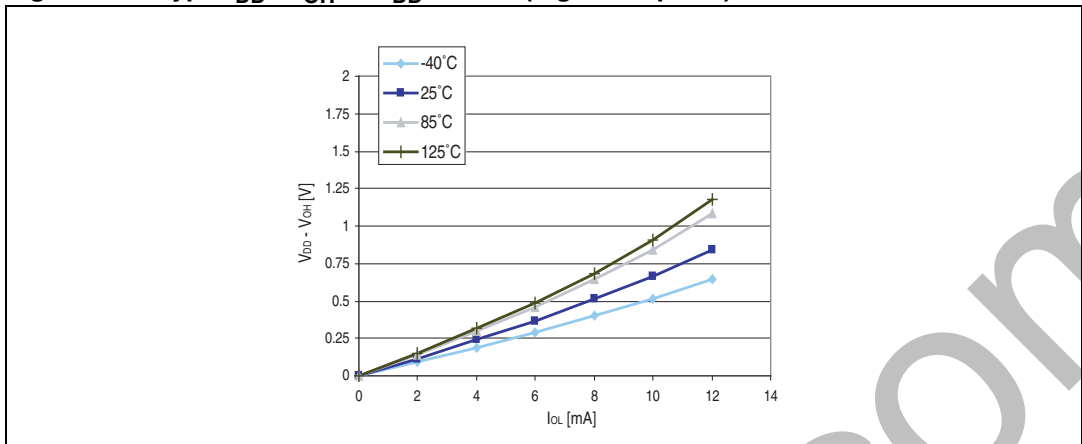


Figure 32. Typ. $V_{DD} - V_{OH}$ @ $V_{DD} = 3.3$ V (high sink ports)



10.3.7 Reset pin characteristics

Subject to general operating conditions for V_{DD} and T_A unless otherwise specified.

Table 41. NRST pin characteristics

Symbol	Parameter	Conditions	Min	Typ ¹⁾	Max	Unit
$V_{IL(NRST)}$	NRST Input low level voltage ⁽¹⁾		-0.3 V		$0.3 \times V_{DD}$	V
$V_{IH(NRST)}$	NRST Input high level voltage ⁽¹⁾		$0.7 \times V_{DD}$		$V_{DD} + 0.3$	
$V_{OL(NRST)}$	NRST Output low level voltage ⁽¹⁾	$I_{OL} = 2$ mA			0.5	kΩ
$R_{PU(NRST)}$	NRST Pull-up resistor ⁽²⁾		30	40	60	
$t_{IFP(NRST)}$	NRST Input filtered pulse ⁽³⁾				75	ns
$t_{INFP(NRST)}$	NRST Input not filtered pulse ⁽³⁾		500			ns
$t_{OP(NRST)}$	NRST output pulse ⁽¹⁾		15			μs

1. Data based on characterization results, not tested in production.
2. The R_{PU} pull-up equivalent resistor is based on a resistive transistor
3. Data guaranteed by design, not tested in production.

Figure 33. Typical NRST V_{IL} and V_{IH} vs V_{DD} @ 4 temperatures

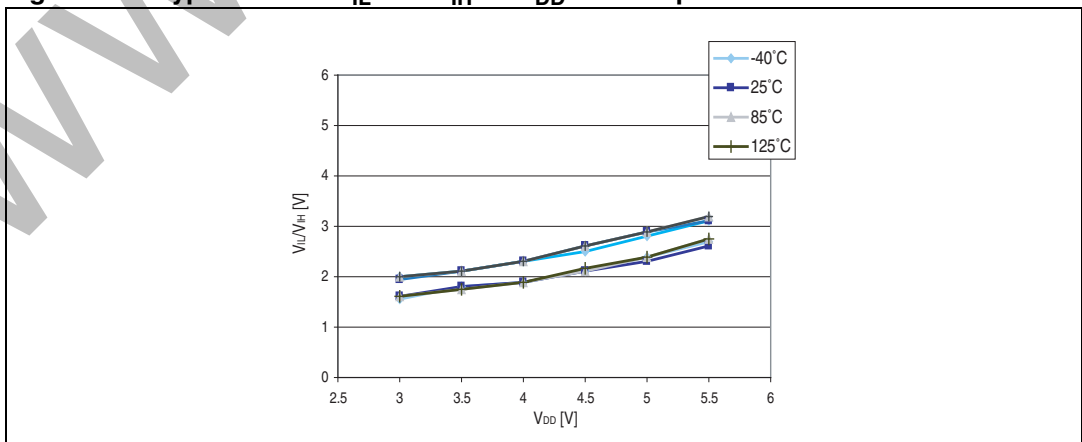


Figure 34. Typical NRST pull-up resistance vs V_{DD} @ 4 temperatures

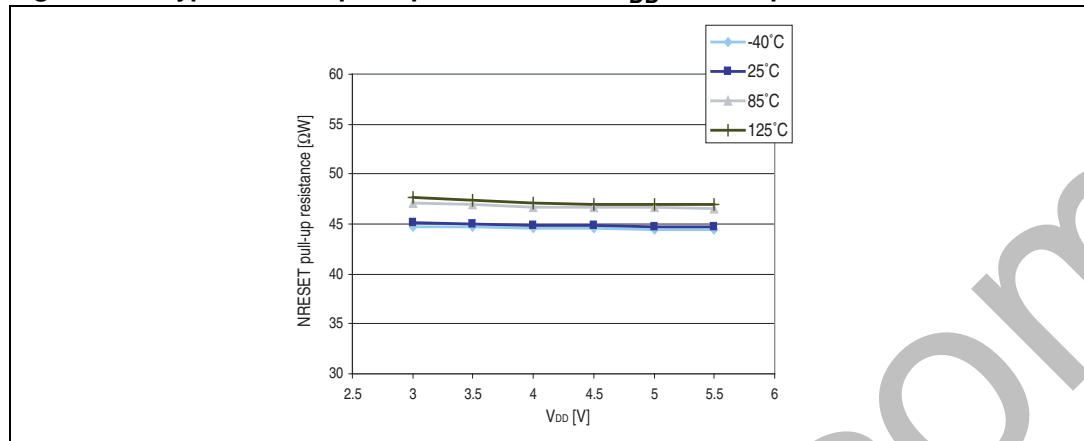
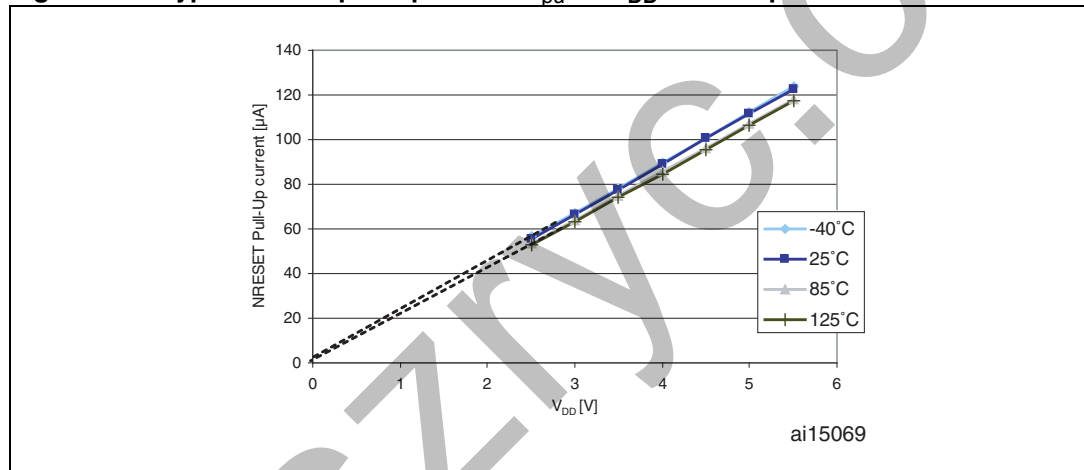
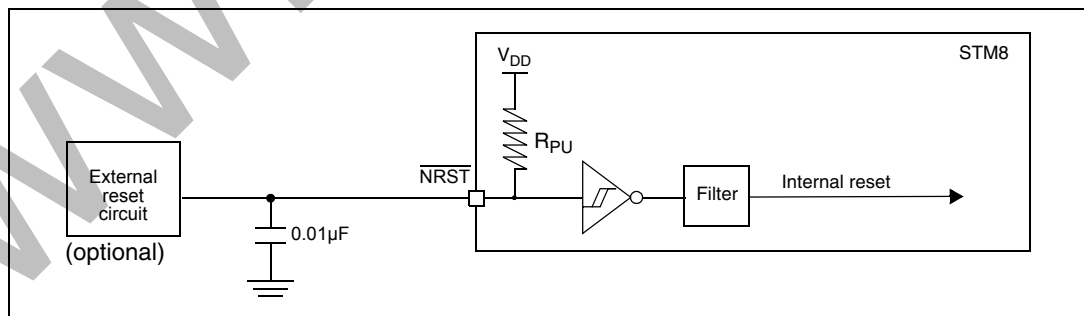


Figure 35. Typical NRST pull-up current I_{PU} vs V_{DD} @ 4 temperatures



The reset network shown in [Figure 36](#) protects the device against parasitic resets. The user must ensure that the level on the NRST pin can go below the V_{IL} max. level specified in [Table 37](#). Otherwise the reset is not taken into account internally.

Figure 36. Recommended reset pin protection



10.3.8 SPI serial peripheral interface

Unless otherwise specified, the parameters given in [Table 42](#) are derived from tests performed under ambient temperature, f_{MASTER} frequency and V_{DD} supply voltage conditions. $t_{\text{MASTER}} = 1/f_{\text{MASTER}}$.

Refer to I/O port characteristics for more details on the input/output alternate function characteristics (NSS, SCK, MOSI, MISO).

Table 42. SPI characteristics

Symbol	Parameter	Conditions	Min	Max	Unit
f_{SCK} $1/t_{\text{c(SCK)}}$	SPI clock frequency	Master mode	0	10	MHz
		Slave mode	0	6	
$t_{\text{r(SCK)}}$ $t_{\text{f(SCK)}}$	SPI clock rise and fall time	Capacitive load: C = 30 pF		25	ns
$t_{\text{su(NSS)}}^{(1)}$	NSS setup time	Slave mode	$4 \times t_{\text{MASTER}}$		
$t_{\text{h(NSS)}}^{(1)}$	NSS hold time	Slave mode	70		
$t_{\text{w(SCKH)}}^{(1)}$ $t_{\text{w(SCKL)}}^{(1)}$	SCK high and low time	Master mode	$t_{\text{SCK}}/2 - 15$	$t_{\text{SCK}}/2 + 15$	
$t_{\text{su(MI)}}^{(1)}$ $t_{\text{su(SI)}}^{(1)}$	Data input setup time	Master mode	5		
		Slave mode	5		
$t_{\text{h(MI)}}^{(1)}$ $t_{\text{h(SI)}}^{(1)}$	Data input hold time	Master mode	7		
		Slave mode	10		
$t_{\text{a(SO)}}^{(1)(2)}$	Data output access time	Slave mode		$3 \times t_{\text{MASTER}}$	
$t_{\text{dis(SO)}}^{(1)(3)}$	Data output disable time	Slave mode	25		
$t_{\text{v(SO)}}^{(1)}$	Data output valid time	Slave mode (after enable edge)		75	
$t_{\text{v(MO)}}^{(1)}$	Data output valid time	Master mode (after enable edge)		30	
$t_{\text{h(SO)}}^{(1)}$ $t_{\text{h(MO)}}^{(1)}$	Data output hold time	Slave mode (after enable edge)	31		
		Master mode (after enable edge)	12		

1. Values based on design simulation and/or characterization results, and not tested in production.
2. Min time is for the minimum time to drive the output and the max time is for the maximum time to validate the data.
3. Min time is for the minimum time to invalidate the output and the max time is for the maximum time to put the data in Hi-Z.

Figure 37. SPI timing diagram - slave mode and CPHA = 0

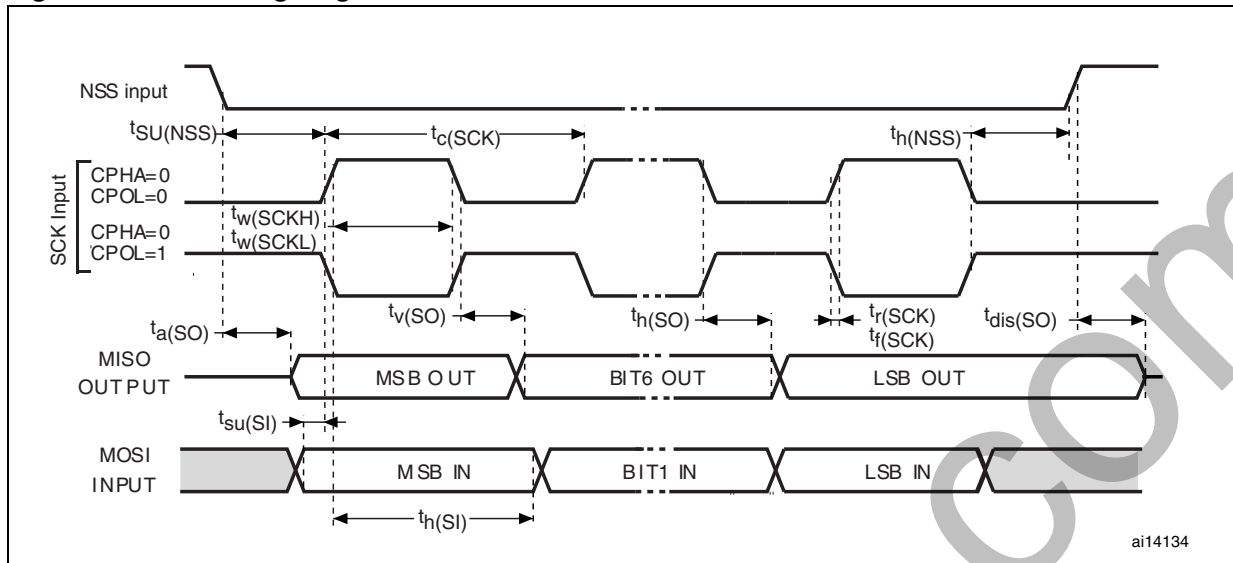
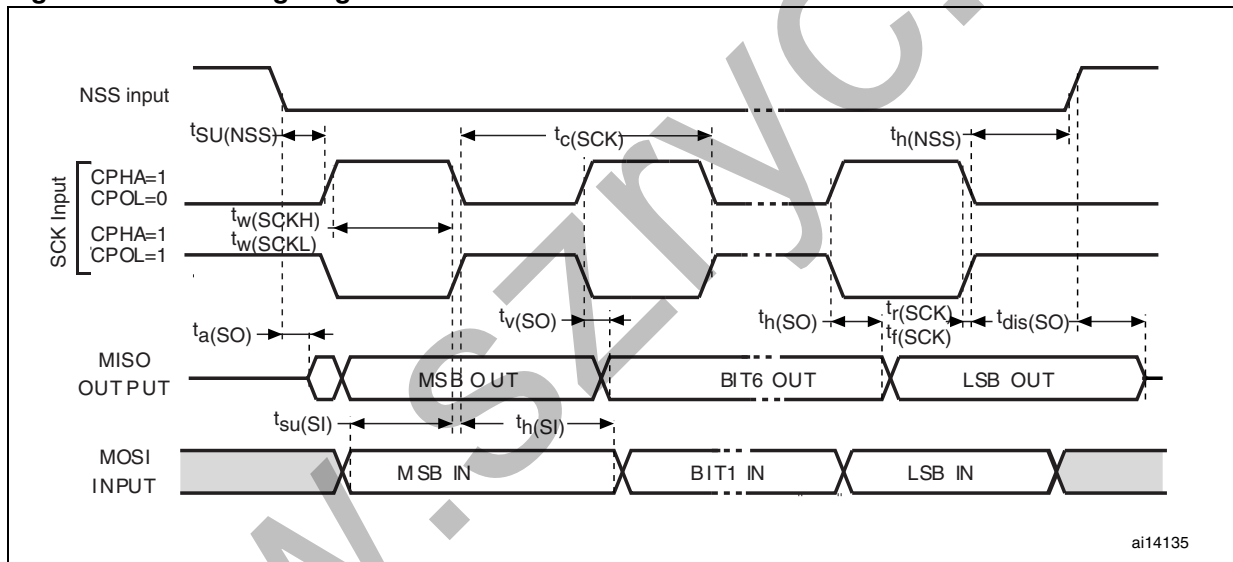
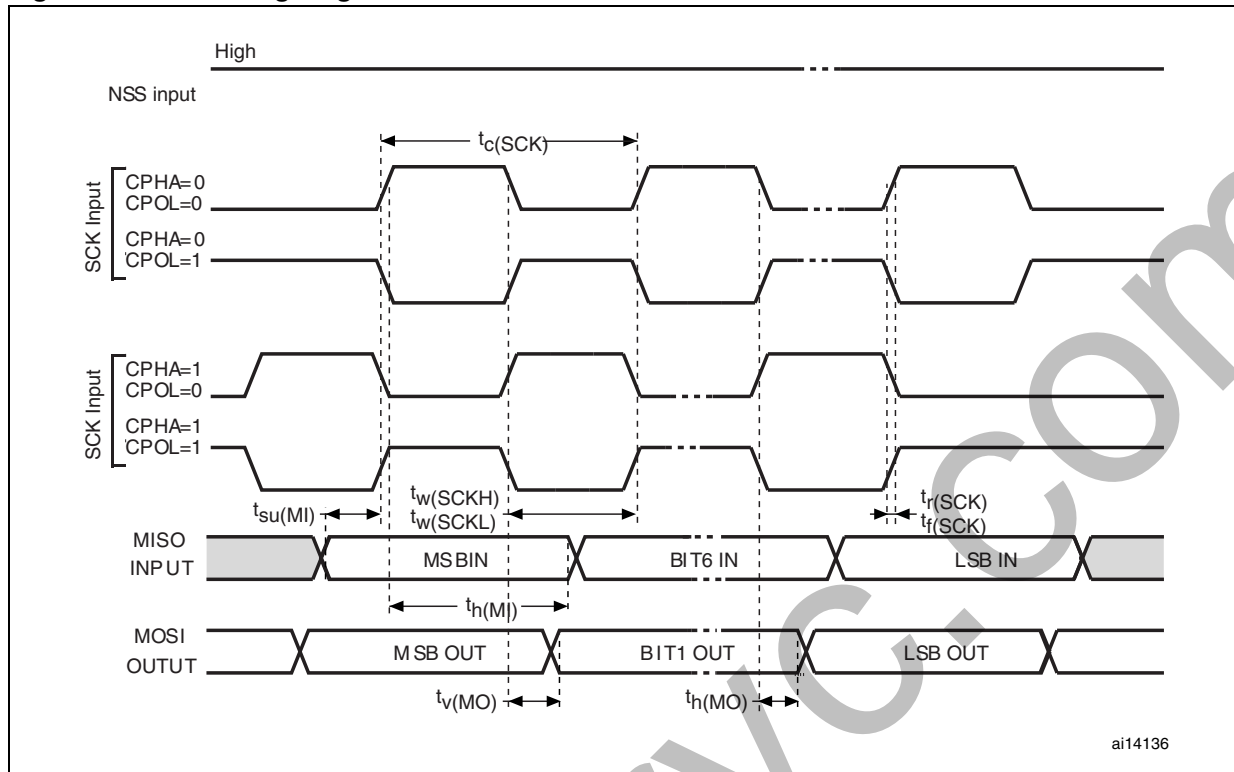


Figure 38. SPI timing diagram - slave mode and CPHA = 1⁽¹⁾



1. Measurement points are done at CMOS levels: 0.3 V_{DD} and 0.7 V_{DD}.

Figure 39. SPI timing diagram - master mode⁽¹⁾



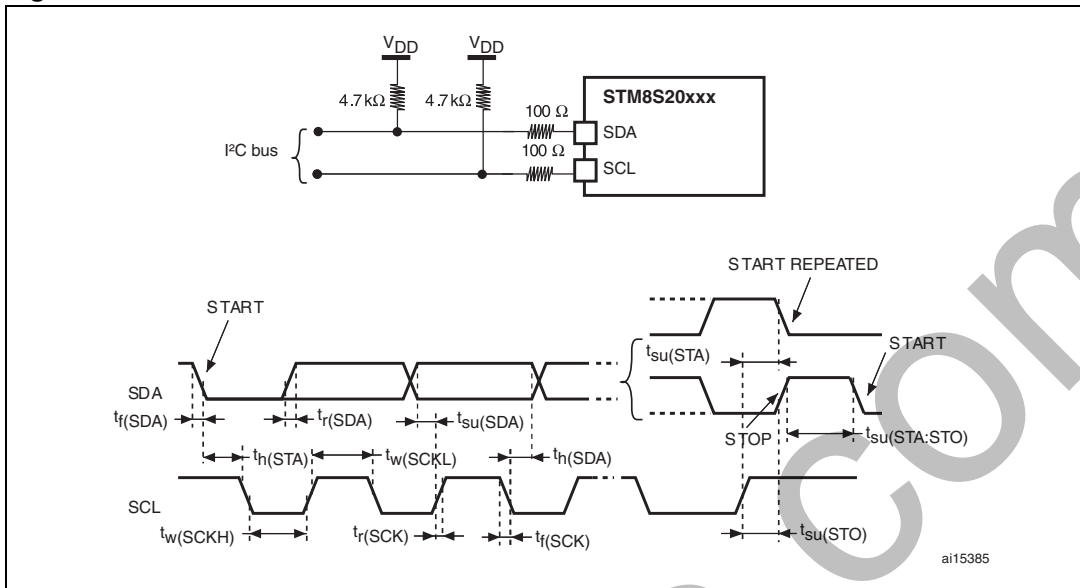
1. Measurement points are done at CMOS levels: $0.3 V_{DD}$ and $0.7 V_{DD}$.

10.3.9 I²C interface characteristicsTable 43. I²C characteristics

Symbol	Parameter	Standard mode I ² C		Fast mode I ² C ⁽¹⁾		Unit
		Min ⁽²⁾	Max ⁽²⁾	Min ⁽²⁾	Max ⁽²⁾	
t _{w(SCLL)}	SCL clock low time	4.7		1.3		μs
t _{w(SCLH)}	SCL clock high time	4.0		0.6		
t _{su(SDA)}	SDA setup time	250		100		ns
t _{h(SDA)}	SDA data hold time	0 ⁽³⁾		0 ⁽⁴⁾	900 ⁽³⁾	
t _{r(SDA)} t _{r(SCL)}	SDA and SCL rise time		1000		300	
t _{f(SDA)} t _{f(SCL)}	SDA and SCL fall time		300		300	
t _{h(STA)}	START condition hold time	4.0		0.6		μs
t _{su(STA)}	Repeated START condition setup time	4.7		0.6		
t _{su(STO)}	STOP condition setup time	4.0		0.6		μs
t _{w(STO:STA)}	STOP to START condition time (bus free)	4.7		1.3		μs
C _b	Capacitive load for each bus line		400		400	pF

1. f_{MASTER} must be at least 8 MHz to achieve max fast I²C speed (400kHz)
2. Data based on standard I²C protocol requirement, not tested in production
3. The maximum hold time of the start condition has only to be met if the interface does not stretch the low time
4. The device must internally provide a hold time of at least 300 ns for the SDA signal in order to bridge the undefined region of the falling edge of SCL

Figure 40. Typical application with I²C bus and timing diagram⁽¹⁾



1. Measurement points are done at CMOS levels: 0.3 x V_{DD} and 0.7 x V_{DD}

10.3.10 10-bit ADC characteristics

Subject to general operating conditions for V_{DDA} , f_{MASTER} , and T_A unless otherwise specified.

Table 44. ADC characteristics

Symbol	Parameter	Conditions	Min	Typ	Max	Unit
f_{ADC}	ADC clock frequency	$V_{DDA} = 3$ to 5.5 V	1		4	MHz
		$V_{DDA} = 4.5$ to 5.5 V	1		6	
V_{DDA}	Analog supply		3		5.5	V
V_{REF+}	Positive reference voltage		2.75 ⁽¹⁾		V_{DDA}	V
V_{REF-}	Negative reference voltage		V_{SSA}		0.5 ⁽¹⁾	V
V_{AIN}	Conversion voltage range ⁽²⁾		V_{SSA}		V_{DDA}	V
		Devices with external V_{REF+}/V_{REF-} pins	V_{REF-}		V_{REF+}	V
C_{ADC}	Internal sample and hold capacitor			3		pF
$t_S^{(2)}$	Sampling time	$f_{ADC} = 4$ MHz		0.75		μ s
		$f_{ADC} = 6$ MHz		0.5		
t_{STAB}	Wakeup time from standby			7		μ s
t_{CONV}	Total conversion time (including sampling time, 10-bit resolution)	$f_{ADC} = 4$ MHz		3.5		μ s
		$f_{ADC} = 6$ MHz		2.33		μ s
				14		$1/f_{ADC}$

1. Data guaranteed by design, not tested in production..

2. During the sample time the input capacitance C_{AIN} (3 pF max) can be charged/discharged by the external source. The internal resistance of the analog source must allow the capacitance to reach its final voltage level within t_S . After the end of the sample time t_S , changes of the analog input voltage have no effect on the conversion result. Values for the sample clock t_S depend on programming.

Table 45. ADC accuracy with $R_{AIN} < 10\text{ k}\Omega$, $V_{DDA} = 5\text{ V}$

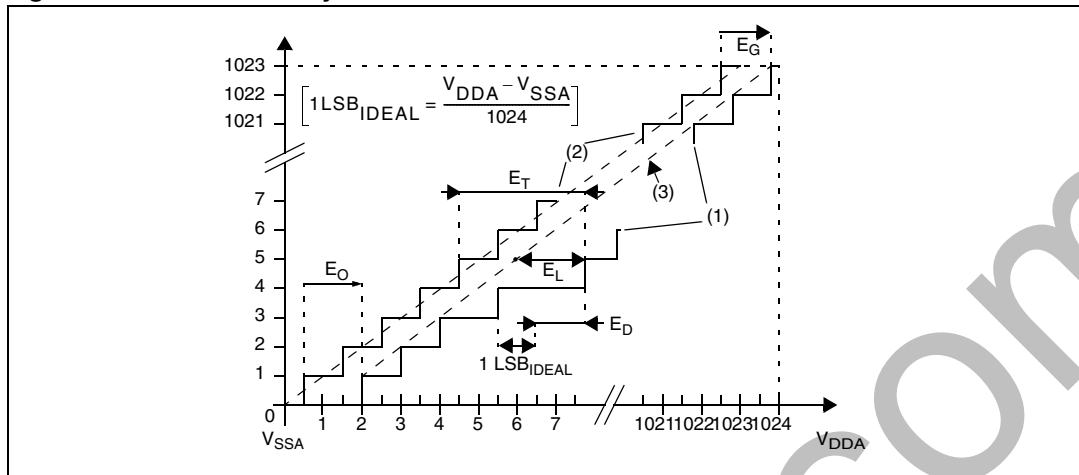
Symbol	Parameter	Conditions	Typ	Max ⁽¹⁾	Unit
E _T	Total unadjusted error ⁽²⁾	f _{ADC} = 2 MHz.	1	2.5	LSB
		f _{ADC} = 4 MHz.	1.4	3	
		f _{ADC} = 6 MHz.	1.6	3.5	
E _O	Offset error ⁽²⁾	f _{ADC} = 2 MHz.	0.6	2	
		f _{ADC} = 4 MHz.	1.1	2.5	
		f _{ADC} = 6 MHz.	1.2	2.5	
E _G	Gain error ⁽²⁾	f _{ADC} = 2 MHz.	0.2	2	
		f _{ADC} = 4 MHz.	0.6	2.5	
		f _{ADC} = 6 MHz.	0.8	2.5	
E _D	Differential linearity error ⁽²⁾	f _{ADC} = 2 MHz.	0.7	1.5	
		f _{ADC} = 4 MHz.	0.7	1.5	
		f _{ADC} = 6 MHz.	0.8	1.5	
E _L	Integral linearity error ⁽²⁾	f _{ADC} = 2 MHz.	0.6	1.5	
		f _{ADC} = 4 MHz.	0.6	1.5	
		f _{ADC} = 6 MHz.	0.6	1.5	

1. Data based on characterisation results for LQFP80 device with V_{REF+}/V_{REF-}, not tested in production.
2. ADC accuracy vs. negative injection current: Injecting negative current on any of the analog input pins should be avoided as this significantly reduces the accuracy of the conversion being performed on another analog input. It is recommended to add a Schottky diode (pin to ground) to standard analog pins which may potentially inject negative current. Any positive injection current within the limits specified for I_{INJ(PIN)} and ΣI_{INJ(PIN)} in [Section 10.3.6](#) does not affect the ADC accuracy.

Table 46. ADC accuracy with $R_{AIN} < 10\text{ k}\Omega$, R_{AIN} , $V_{DDA} = 3.3\text{ V}$

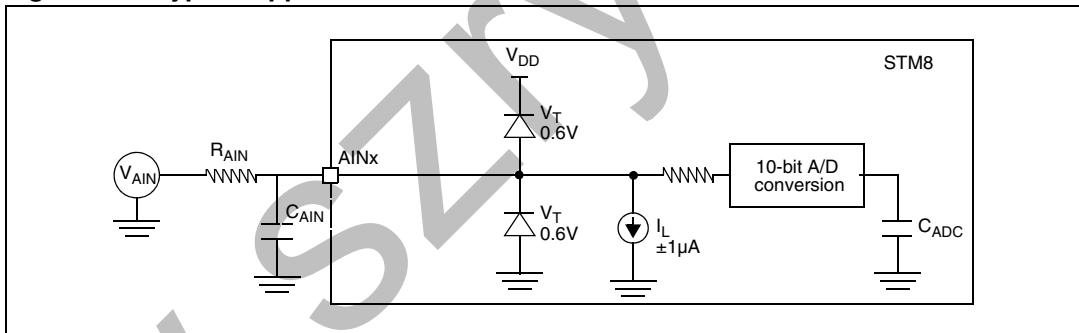
Symbol	Parameter	Conditions	Typ	Max ⁽¹⁾	Unit
E _T	Total unadjusted error ⁽²⁾	f _{ADC} = 2 MHz.	1.1	2	LSB
		f _{ADC} = 4 MHz.	1.6	2.5	
E _O	Offset error ⁽²⁾	f _{ADC} = 2 MHz.	0.7	1.5	
		f _{ADC} = 4 MHz.	1.3	2	
E _G	Gain error ⁽²⁾	f _{ADC} = 2 MHz.	0.2	1.5	
		f _{ADC} = 4 MHz.	0.5	2	
E _D	Differential linearity error ⁽²⁾	f _{ADC} = 2 MHz.	0.7	1	
		f _{ADC} = 4 MHz.	0.7	1	
E _L	Integral linearity error ⁽²⁾	f _{ADC} = 2 MHz.	0.6	1.5	
		f _{ADC} = 4 MHz.	0.6	1.5	

Figure 41. ADC accuracy characteristics



1. Example of an actual transfer curve.
 2. The ideal transfer curve
 3. End point correlation line
- E_T** = Total unadjusted error: maximum deviation between the actual and the ideal transfer curves.
E_O = Offset error: deviation between the first actual transition and the first ideal one.
E_G = Gain error: deviation between the last ideal transition and the last actual one.
E_D = Differential linearity error: maximum deviation between actual steps and the ideal one.
E_L = Integral linearity error: maximum deviation between any actual transition and the end point correlation line.

Figure 42. Typical application with ADC



10.3.11 EMC characteristics

Susceptibility tests are performed on a sample basis during product characterization.

Functional EMS (electromagnetic susceptibility)

While executing a simple application (toggling 2 LEDs through I/O ports), the product is stressed by two electromagnetic events until a failure occurs (indicated by the LEDs).

- **ESD:** Electrostatic discharge (positive and negative) is applied on all pins of the device until a functional disturbance occurs. This test conforms with the IEC 61000-4-2 standard.
- **FTB:** A burst of fast transient voltage (positive and negative) is applied to V_{DD} and V_{SS} through a 100 pF capacitor, until a functional disturbance occurs. This test conforms with the IEC 61000-4-4 standard.

A device reset allows normal operations to be resumed. The test results are given in the table below based on the EMS levels and classes defined in application note AN1709.

Designing hardened software to avoid noise problems

EMC characterization and optimization are performed at component level with a typical application environment and simplified MCU software. It should be noted that good EMC performance is highly dependent on the user application and the software in particular.

Therefore it is recommended that the user applies EMC software optimization and prequalification tests in relation with the EMC level requested for his application.

Software recommendations

The software flowchart must include the management of runaway conditions such as:

- Corrupted program counter
- Unexpected reset
- Critical data corruption (control registers...)

Prequalification trials

Most of the common failures (unexpected reset and program counter corruption) can be recovered by applying a low state on the NRST pin or the oscillator pins for 1 second.

To complete these trials, ESD stress can be applied directly on the device, over the range of specification values. When unexpected behavior is detected, the software can be hardened to prevent unrecoverable errors occurring (see application note AN1015).

Table 47. EMS data

Symbol	Parameter	Conditions	Level/class
V_{FESD}	Voltage limits to be applied on any I/O pin to induce a functional disturbance	$V_{DD} = 5\text{ V}$, $T_A = 25\text{ }^\circ\text{C}$, $f_{MASTER} = 16\text{ MHz}$, conforming to IEC 61000-4-2	2B
V_{EFTB}	Fast transient voltage burst limits to be applied through 100pF on V_{DD} and V_{SS} pins to induce a functional disturbance	$V_{DD} = 5\text{ V}$, $T_A = 25\text{ }^\circ\text{C}$, $f_{MASTER} = 16\text{ MHz}$, conforming to IEC 61000-4-4	4A

Electromagnetic interference (EMI)

Emission tests conform to the SAE IEC 61967-2 standard for test software, board layout and pin loading.

Table 48. EMI data

Symbol	Parameter	Conditions					Unit
		General conditions	Monitored frequency band	Max $f_{HSE}/f_{CPU}^{(1)}$			
				8 MHz/8 MHz	8 MHz/16 MHz	8 MHz/24 MHz	
S_{EMI}	Peak level	$V_{DD} = 5\text{ V}$ $T_A = 25\text{ °C}$ LQFP80 package conforming to SAE IEC 61967-2	0.1MHz to 30 MHz	15	20	24	dB μ V
			30 MHz to 130 MHz	18	21	16	
			130 MHz to 1 GHz	-1	1	4	
	SAE EMI level		SAE EMI level	2	2.5	2.5	

1. Data based on characterization results, not tested in production.

Absolute maximum ratings (electrical sensitivity)

Based on two different tests (ESD and LU) using specific measurement methods, the product is stressed in order to determine its performance in terms of electrical sensitivity. For more details, refer to the application note AN1181.

Electrostatic discharge (ESD)

Electrostatic discharges (3 positive then 3 negative pulses separated by 1 second) are applied to the pins of each sample according to each pin combination. The sample size depends on the number of supply pins in the device (3 parts*(n+1) supply pin). This test conforms to the JESD22-A114A/A115A standard. For more details, refer to the application note AN1181.

Table 49. ESD absolute maximum ratings

Symbol	Ratings	Conditions	Class	Maximum value ⁽¹⁾	Unit
$V_{ESD(HBM)}$	Electrostatic discharge voltage (Human body model)	$T_A = 25\text{ °C}$, conforming to JESD22-A114	A	2000	V
$V_{ESD(CDM)}$	Electrostatic discharge voltage (Charge device model)	$T_A = 25\text{ °C}$, conforming to JESD22-C101	IV	1000	V

1. Data based on characterization results, not tested in production.

Static latch-up

Two complementary static tests are required on 10 parts to assess the latch-up performance:

- A supply overvoltage (applied to each power supply pin)
- A current injection (applied to each input, output and configurable I/O pin) is performed on each sample.

This test conforms to the EIA/JESD 78 IC latch-up standard. For more details, refer to the application note AN1181.

Table 50. Electrical sensitivities

Symbol	Parameter	Conditions	Class ⁽¹⁾
LU	Static latch-up class	T _A = 25 °C	A
		T _A = 85 °C	A
		T _A = 125 °C	A

1. Class description: A Class is an STMicroelectronics internal specification. All its limits are higher than the JEDEC specifications, that means when a device belongs to class A it exceeds the JEDEC standard. B class strictly covers all the JEDEC criteria (international standard).



11 Package characteristics

To meet environmental requirements, ST offers these devices in different grades of ECOPACK® packages, depending on their level of environmental compliance. ECOPACK® specifications, grade definitions and product status are available at www.st.com. ECOPACK® is an ST trademark.

WWW.SZRYC.COM

11.1 Package mechanical data

11.1.1 LQFP package mechanical data

Figure 43. 80-pin low profile quad flat package (14 x 14)

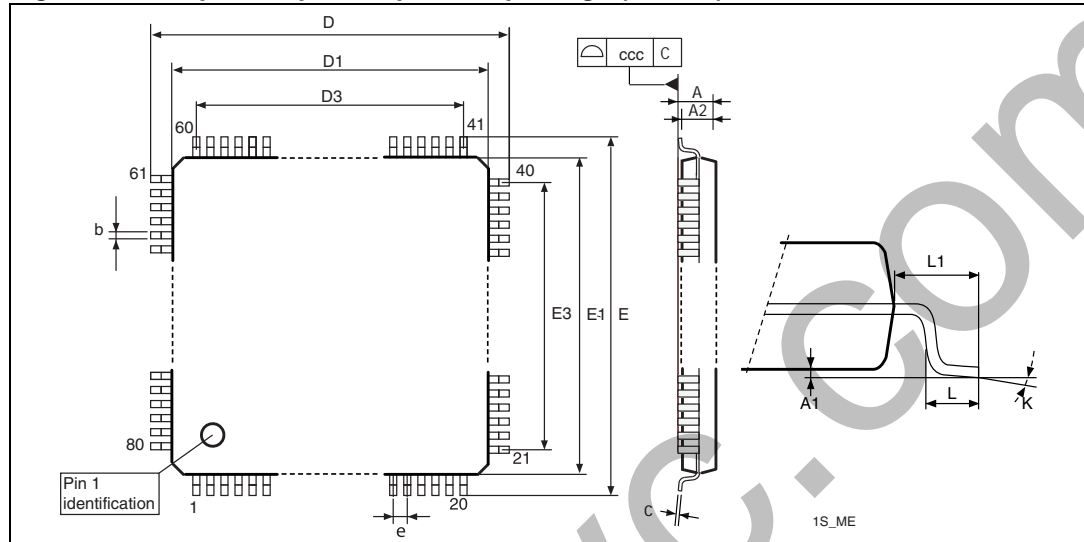


Table 51. 80-pin low profile quad flat package mechanical data

Symbol	mm			inches ⁽¹⁾		
	Min	Typ	Max	Min	Typ	Max
A			1.600			0.0630
A1	0.050		0.150	0.0020		0.0059
A2	1.350	1.400	1.450	0.0531	0.0551	0.0571
b	0.220	0.320	0.380	0.0087	0.0126	0.0150
c	0.090		0.200	0.0035		0.0079
D	15.800	16.000	16.200	0.6220	0.6299	0.6378
D1	13.800	14.000	14.200	0.5433	0.5512	0.5591
D3		12.350			0.4862	
E	15.800	16.000	16.200	0.6220	0.6299	0.6378
E1	13.800	14.000	14.200	0.5433	0.5512	0.5591
E3		12.350			0.4862	
e		0.650			0.0256	
L	0.450	0.600	0.750	0.0177	0.0236	0.0295
L1		1.000			0.0394	
k	0.0°	3.5°	7.0°	0.0°	3.5°	7.0°
ccc			0.100			0.0039

1. Values in inches are converted from mm and rounded to four decimal places.

Figure 44. 64-pin low profile quad flat package (14 x 14)

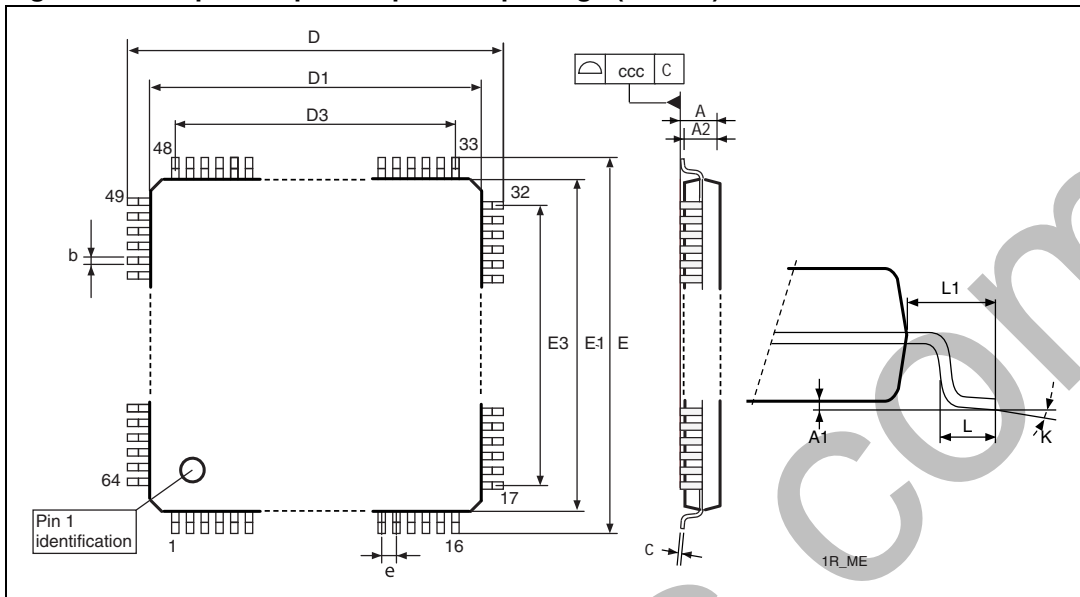


Table 52. 64-pin low profile quad flat package mechanical data (14 x 14)

Symbol	mm			inches ⁽¹⁾		
	Min	Typ	Max	Min	Typ	Max
A			1.600			0.0630
A1	0.050		0.150	0.0020		0.0059
A2	1.350	1.400	1.450	0.0531	0.0551	0.0571
b	0.300	0.370	0.450	0.0118	0.0146	0.0177
C	0.090		0.200	0.0035		0.0079
D	15.800	16.000	16.200	0.6220	0.6299	0.6378
D1	13.800	14.000	14.200	0.5433	0.5512	0.5591
D3		12.000			0.4724	
E	15.800	16.000	16.200	0.6220	0.6299	0.6378
E1	13.800	14.000	14.200	0.5433	0.5512	0.5591
E3		12.000			0.4724	
e		0.800			0.0315	
L	0.450	0.600	0.750	0.0177	0.0236	0.0295
L1		1.000			0.0394	
k	0.0 °	3.5 °	7.0 °	0.0 °	3.5 °	7.0 °
ccc			0.100			0.0039

1. Values in inches are converted from mm and rounded to four decimal places.

Figure 45. 64-pin low profile quad flat package (10 x 10)

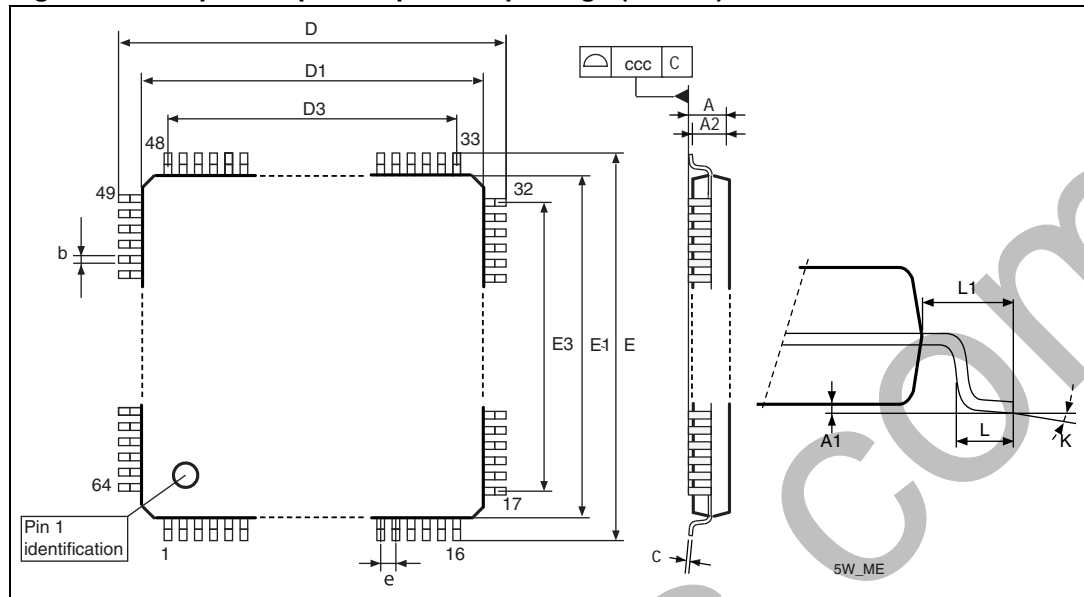


Table 53. 64-pin low profile quad flat package mechanical data (10 x 10)

Symbol	mm			inches ⁽¹⁾		
	Min	Typ	Max	Min	Typ	Max
A			1.600			0.0630
A1	0.050		0.150	0.0020		0.0059
A2	1.350	1.400	1.450	0.0531	0.0551	0.0571
b	0.170	0.220	0.270	0.0067	0.0087	0.0106
C	0.090		0.200	0.0035		0.0079
D		12.000			0.4724	
D1		10.000			0.3937	
E		12.000			0.4724	
E1		10.000			0.3937	
e		0.500			0.0197	
K	0.000°	3.500°	7.000°	0.0000°	3.5000°	7.0000°
L	0.450	0.600	0.750	0.0177	0.0236	0.0295
L1		1.000			0.0394	

1. Values in inches are converted from mm and rounded to four decimal places.

Figure 46. 48-pin low profile quad flat package (7 x 7)

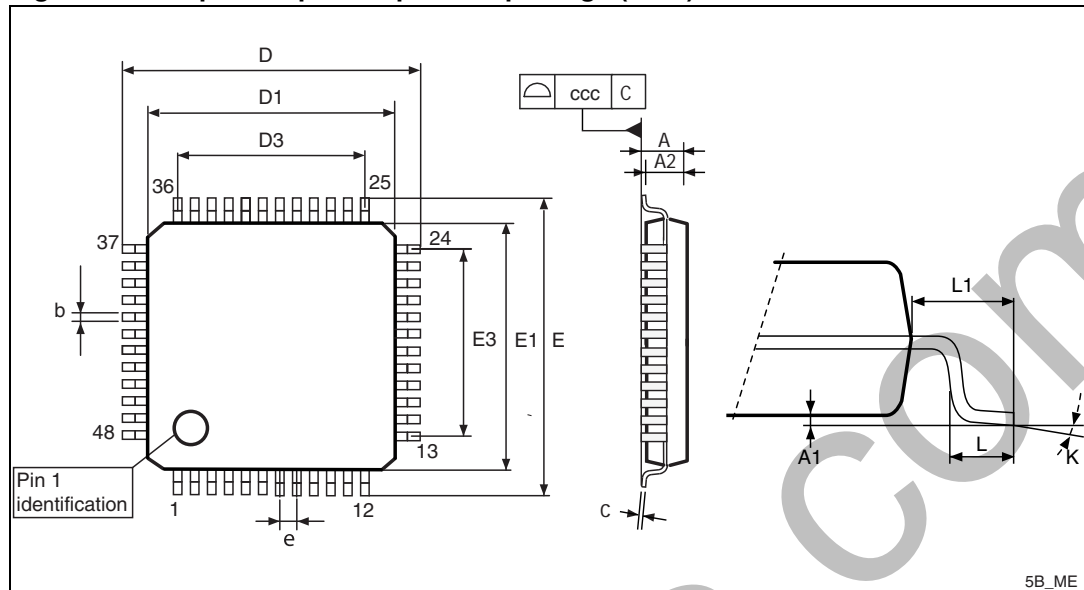


Table 54. 48-pin low profile quad flat package mechanical data

Symbol	mm			inches ⁽¹⁾		
	Min	Typ	Max	Min	Typ	Max
A			1.600			0.0630
A1	0.050		0.150	0.0020		0.0059
A2	1.350	1.400	1.450	0.0531	0.0551	0.0571
b	0.170	0.220	0.270	0.0067	0.0087	0.0106
c	0.090		0.200	0.0035		0.0079
D	8.800	9.000	9.200	0.3465	0.3543	0.3622
D1	6.800	7.000	7.200	0.2677	0.2756	0.2835
D3		5.500			0.2165	
E	8.800	9.000	9.200	0.3465	0.3543	0.3622
E1	6.800	7.000	7.200	0.2677	0.2756	0.2835
E3		5.500			0.2165	
e		0.500			0.0197	
L	0.450	0.600	0.750	0.0177	0.0236	0.0295
L1		1.000			0.0394	
k	0.0°	3.5°	7.0°	0.0°	3.5°	7.0°
ccc			0.080			0.0031

1. Values in inches are converted from mm and rounded to four decimal places.

Figure 47. 44-pin low profile quad flat package (10 x 10)

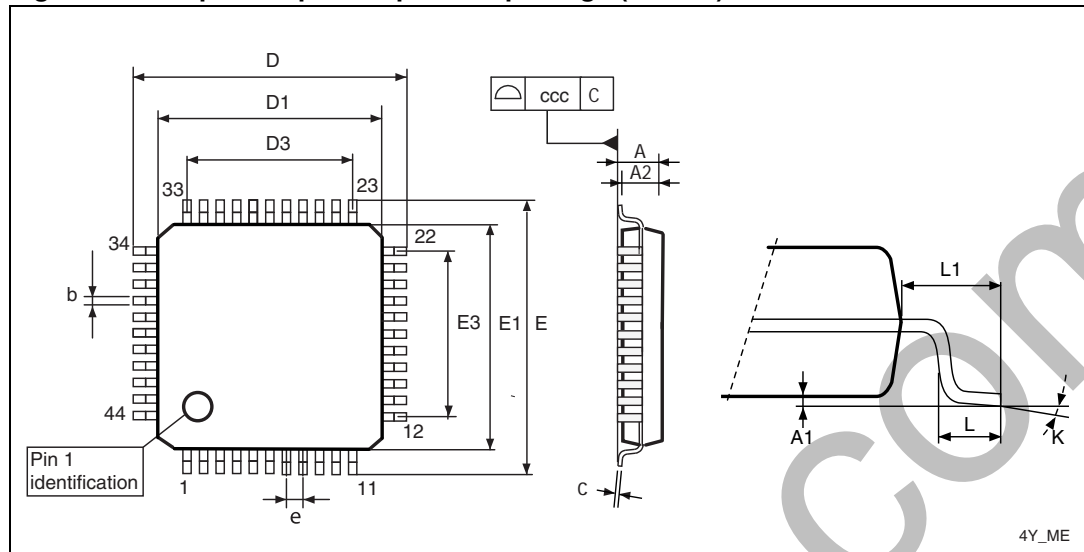


Table 55. 44-pin low profile quad flat package mechanical data

Symbol	mm			inches ⁽¹⁾		
	Min	Typ	Max	Min	Typ	Max
A			1.600			0.0630
A1	0.050		0.150	0.0020		0.0059
A2	1.350	1.400	1.450	0.0531	0.0551	0.0571
b	0.300	0.370	0.450	0.0118	0.0146	0.0177
c	0.090		0.200	0.0035		0.0079
D	11.800	12.000	12.200	0.4646	0.4724	0.4803
D1	9.800	10.000	10.200	0.3858	0.3937	0.4016
D3		8.000			0.3150	
E	11.800	12.000	12.200	0.4646	0.4724	0.4803
E1	9.800	10.000	10.200	0.3858	0.3937	0.4016
E3		8.000			0.3150	
e		0.800			0.0315	
L	0.450	0.600	0.750	0.0177	0.0236	0.0295
L1		1.000			0.0394	
k	0.0°	3.5°	7.0°	0.0°	3.5°	7.0°
ccc			0.100			0.0039

1. Values in inches are converted from mm and rounded to four decimal places.

Figure 48. 32-pin low profile quad flat package (7 x 7)

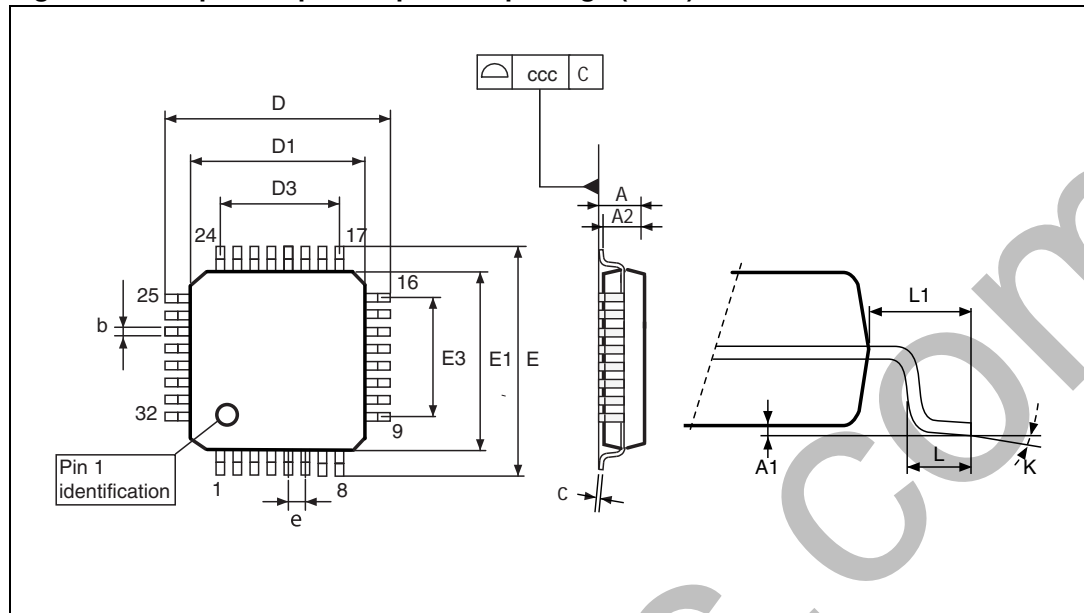


Table 56. 32-pin low profile quad flat package mechanical data

Symbol	mm			inches ⁽¹⁾		
	Min	Typ	Max	Min	Typ	Max
A			1.600			0.0630
A1	0.050		0.150	0.0020		0.0059
A2	1.350	1.400	1.450	0.0531	0.0551	0.0571
b	0.300	0.370	0.450	0.0118	0.0146	0.0177
c	0.090		0.200	0.0035		0.0079
D	8.800	9.000	9.200	0.3465	0.3543	0.3622
D1	6.800	7.000	7.200	0.2677	0.2756	0.2835
D3		5.600			0.2205	
E	8.800	9.000	9.200	0.3465	0.3543	0.3622
E1	6.800	7.000	7.200	0.2677	0.2756	0.2835
E3		5.600			0.2205	
e		0.800			0.0315	
L	0.450	0.600	0.750	0.0177	0.0236	0.0295
L1		1.000			0.0394	
k	0.0°	3.5°	7.0°	0.0°	3.5°	7.0°
ccc			0.100			0.0039

1. Values in inches are converted from mm and rounded to four decimal places.

11.2 Thermal characteristics

The maximum chip junction temperature (T_{Jmax}) must never exceed the values given in [Table 18: General operating conditions on page 56](#).

The maximum chip-junction temperature, T_{Jmax} , in degrees Celsius, may be calculated using the following equation:

$$T_{Jmax} = T_{Amax} + (P_{Dmax} \times \Theta_{JA})$$

Where:

- T_{Amax} is the maximum ambient temperature in °C
- Θ_{JA} is the package junction-to-ambient thermal resistance in °C/W
- P_{Dmax} is the sum of P_{INTmax} and $P_{I/Omax}$ ($P_{Dmax} = P_{INTmax} + P_{I/Omax}$)
- P_{INTmax} is the product of I_{DD} and V_{DD} , expressed in Watts. This is the maximum chip internal power.
- $P_{I/Omax}$ represents the maximum power dissipation on output pins, where:
 $P_{I/Omax} = \Sigma (V_{OL} * I_{OL}) + \Sigma ((V_{DD} - V_{OH}) * I_{OH})$, and taking account of the actual V_{OL}/I_{OL} and V_{OH}/I_{OH} of the I/Os at low and high level in the application.

Table 57. Thermal characteristics⁽¹⁾

Symbol	Parameter	Value	Unit
Θ_{JA}	Thermal resistance junction-ambient LQFP 80 - 14 x 14 mm	38	°C/W
Θ_{JA}	Thermal resistance junction-ambient LQFP 64 - 14 x 14 mm	45	°C/W
Θ_{JA}	Thermal resistance junction-ambient LQFP 64 - 10 x 10 mm	46	°C/W
Θ_{JA}	Thermal resistance junction-ambient LQFP 48 - 7 x 7 mm	57	°C/W
Θ_{JA}	Thermal resistance junction-ambient LQFP 44 - 10 x 10 mm	54	°C/W
Θ_{JA}	Thermal resistance junction-ambient LQFP 32 - 7 x 7 mm	60	°C/W

1. Thermal resistances are based on JEDEC JESD51-2 with 4-layer PCB in a natural convection environment.

11.2.1 Reference document

JESD51-2 integrated circuits thermal test method environment conditions - natural convection (still air). Available from www.jedec.org.

11.2.2 Selecting the product temperature range

When ordering the microcontroller, the temperature range is specified in the order code (see [Figure 49: STM8S207xx/208xx performance line ordering information scheme^{\(1\)} on page 100](#)).

The following example shows how to calculate the temperature range needed for a given application.

Assuming the following application conditions:

- Maximum ambient temperature $T_{Amax} = 82\text{ °C}$ (measured according to JESD51-2)
- $I_{DDmax} = 15\text{ mA}$, $V_{DD} = 5.5\text{ V}$
- Maximum eight standard I/Os used at the same time in output at low level with $I_{OL} = 10\text{ mA}$, $V_{OL} = 2\text{ V}$
- Maximum four high sink I/Os used at the same time in output at low level with $I_{OL} = 20\text{ mA}$, $V_{OL} = 1.5\text{ V}$
- Maximum two true open drain I/Os used at the same time in output at low level with $I_{OL} = 20\text{ mA}$, $V_{OL} = 2\text{ V}$

$$P_{INTmax} = 15\text{ mA} \times 5.5\text{ V} = 82.5\text{ mW}$$

$$P_{IOmax} = (10\text{ mA} \times 2\text{ V} \times 8) + (20\text{ mA} \times 2\text{ V} \times 2) + (20\text{ mA} \times 1.5\text{ V} \times 4) = 360\text{ mW}$$

This gives: $P_{INTmax} = 82.5\text{ mW}$ and $P_{IOmax} = 360\text{ mW}$:

$$P_{Dmax} = 82.5\text{ mW} + 360\text{ mW}$$

$$\text{Thus: } P_{Dmax} = 443\text{ mW}$$

Using the values obtained in [Table 57: Thermal characteristics on page 96](#) T_{Jmax} is calculated as follows for LQFP64 10 x 10 mm = 46 °C/W:

$$T_{Jmax} = 82\text{ °C} + (46\text{ °C/W} \times 443\text{ mW}) = 82\text{ °C} + 20\text{ °C} = 102\text{ °C}$$

This is within the range of the suffix 6 version parts ($-40 < T_J < 105\text{ °C}$).

In this case, parts must be ordered at least with the temperature range suffix 6.

12 STM8 development tools

Development tools for the STM8 microcontrollers include the full-featured STice emulation system supported by a complete software tool package including C compiler, assembler and integrated development environment with high-level language debugger. In addition, the STM8 is to be supported by a complete range of tools including starter kits, evaluation boards and a low-cost in-circuit debugger/programmer.

12.1 Emulation and in-circuit debugging tools

The STice emulation system offers a complete range of emulation and in-circuit debugging features on a platform that is designed for versatility and cost-effectiveness. In addition, STM8 application development is supported by a low-cost in-circuit debugger/programmer.

The STice is the fourth generation of full featured emulators from STMicroelectronics. It offers new advanced debugging capabilities including profiling and coverage to help detect and eliminate bottlenecks in application execution and dead code when fine tuning an application.

In addition, STice offers in-circuit debugging and programming of STM8 microcontrollers via the STM8 single wire interface module (SWIM), which allows non-intrusive debugging of an application while it runs on the target microcontroller.

For improved cost effectiveness, STice is based on a modular design that allows you to order exactly what you need to meet your development requirements and to adapt your emulation system to support existing and future ST microcontrollers.

STice key features

- Occurrence and time profiling and code coverage (new features)
- Advanced breakpoints with up to 4 levels of conditions
- Data breakpoints
- Program and data trace recording up to 128 KB records
- Read/write on the fly of memory during emulation
- In-circuit debugging/programming via SWIM protocol
- 8-bit probe analyzer
- 1 input and 2 output triggers
- Power supply follower managing application voltages between 1.62 to 5.5 V
- Modularity that allows you to specify the components you need to meet your development requirements and adapt to future requirements
- Supported by free software tools that include integrated development environment (IDE), programming software interface and assembler for STM8.

12.2 Software tools

STM8 development tools are supported by a complete, free software package from STMicroelectronics that includes ST Visual Develop (STVD) IDE and the ST Visual Programmer (STVP) software interface. STVD provides seamless integration of the Cosmic and Raisonance C compilers for STM8, which are available in a free version that outputs up to 16 Kbytes of code.

12.2.1 STM8 toolset

STM8 toolset with STVD integrated development environment and STVP programming software is available for free download at www.st.com/mcu. This package includes:

ST Visual Develop – Full-featured integrated development environment from ST, featuring

- Seamless integration of C and ASM toolsets
- Full-featured debugger
- Project management
- Syntax highlighting editor
- Integrated programming interface
- Support of advanced emulation features for STIce such as code profiling and coverage

ST Visual Programmer (STVP) – Easy-to-use, unlimited graphical interface allowing read, write and verify of your STM8 microcontroller's Flash program memory, data EEPROM and option bytes. STVP also offers project mode for saving programming configurations and automating programming sequences.

12.2.2 C and assembly toolchains

Control of C and assembly toolchains is seamlessly integrated into the STVD integrated development environment, making it possible to configure and control the building of your application directly from an easy-to-use graphical interface.

Available toolchains include:

- **Cosmic C compiler for STM8** – Available in a free version that outputs up to 16 Kbytes of code. For more information, see www.cosmic-software.com.
- **Raisonance C compiler for STM8** – Available in a free version that outputs up to 16 Kbytes of code. For more information, see www.raisonance.com.
- **STM8 assembler linker** – Free assembly toolchain included in the STVD toolset, which allows you to assemble and link your application source code.

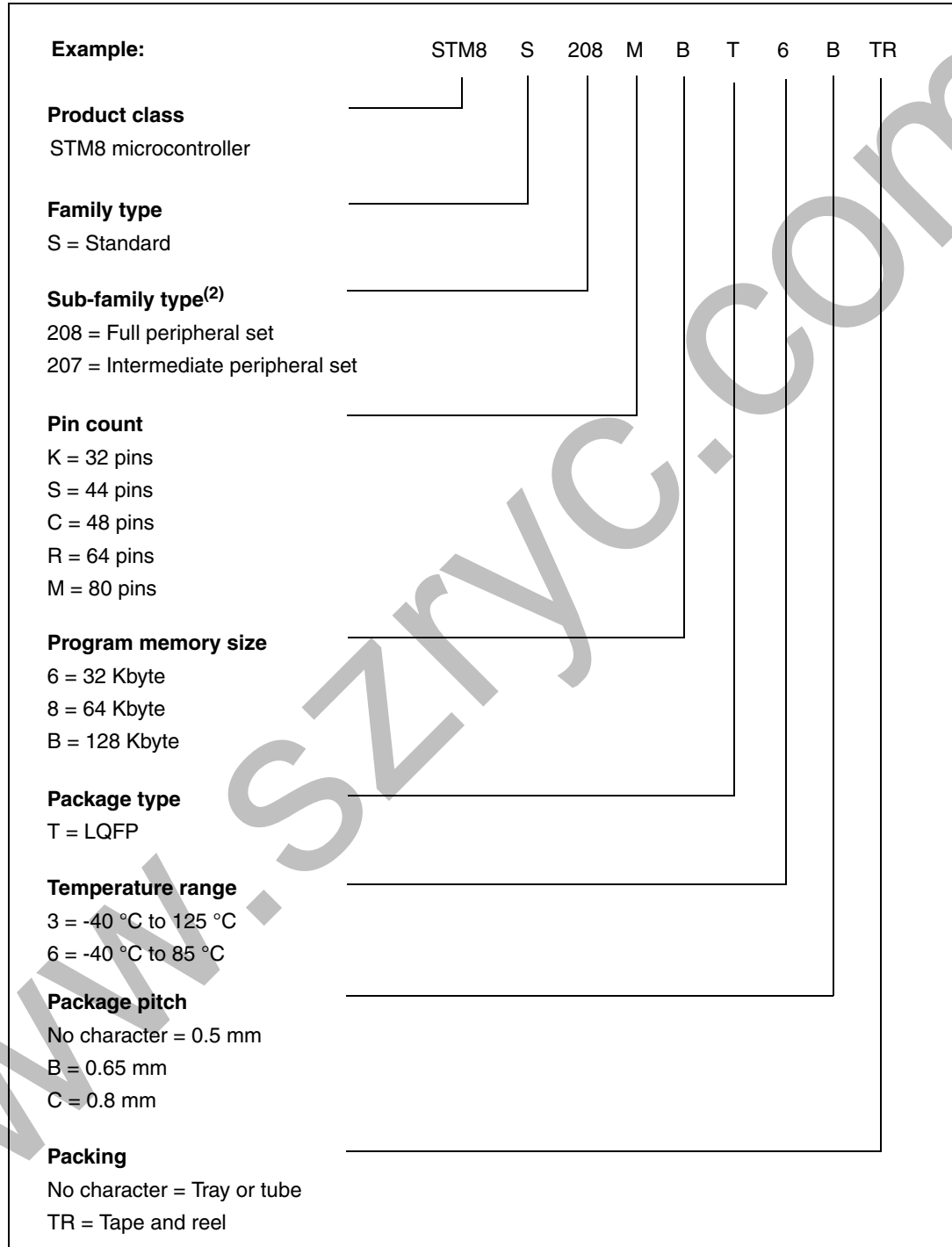
12.3 Programming tools

During the development cycle, STIce provides in-circuit programming of the STM8 Flash microcontroller on your application board via the SWIM protocol. Additional tools are to include a low-cost in-circuit programmer as well as ST socket boards, which provide dedicated programming platforms with sockets for programming your STM8.

For production environments, programmers will include a complete range of gang and automated programming solutions from third-party tool developers already supplying programmers for the STM8 family.

13 Ordering information

Figure 49. STM8S207xx/208xx performance line ordering information scheme⁽¹⁾



1. For a list of available options (e.g. memory size, package) and orderable part numbers or for further information on any aspect of this device, please go to www.st.com or contact the ST Sales Office nearest to you.
2. Refer to [Table 2: STM8S20xxx performance line features](#) for detailed description.



14 Revision history

Table 58. Document revision history

Date	Revision	Changes
23-May-2008	1	Initial release.
05-Jun-2008	2	Added part numbers on page 1 and in Table 2 on page 11 . Updated Section 4: Product overview . Updated Section 10: Electrical characteristics .
22-Jun-2008	3	Added part numbers on page 1 and in Table 2 on page 11 .
12-Aug-2008	4	Added 32 pin device pinout and ordering information. Updated UBC option description in Table 13 on page 48 . USART renamed UART1, LINUART renamed UART3. Max. ADC frequency increased to 6 MHz.
20-Oct-2008	5	Removed STM8S207K4 part number. Removed LQFP64 14 x 14 mm package. Added medium and high density Flash memory categories. Added Section 6: Memory and register map on page 33 . Replaced beCAN3 by beCAN in Section 4.14.5: beCAN . Updated Section 10: Electrical characteristics on page 52 . Updated LQFP44 (Figure 47 and Table 55), and LQFP32 outline and mechanical data (Figure 48 , and Table 56).
08-Dec-2008	6	Changed V_{DD} minimum value from 3.0 to 2.95 V. Updated number of High Sink I/Os in pinout. Removed FLASH_NFPR and FLASH_FPR registers in Table 9: General hardware register map .
30-Jan-2009	7	Removed preliminary status. Removed VQFN32 package. Added STM8S207C6, STM8S207S6. Updated external interrupts in Table 2 on page 11 . Updated Section 10: Electrical characteristics .
10-Jul-2009	8	Document status changed from "preliminary data" to "datasheet". Added LQFP64 14 x 14 mm package. Added STM8S207M8, STM8S207SB, STM8S208R8, STM8S208R6, STM8S208C8, and STM8S208C6, STM8S208SB, STM8S208S8, and STM8S208S6. Replaced "CAN" with "beCAN". Added Table 3 to Section 4.5: Clock controller . Updated Section 4.8: Auto wakeup counter . Added beCAN peripheral (impacting Table 1 and Figure 6). Added footnote about CAN_RX/TX to pinout figures 3 , 4 , and 6 . Table 6 : Removed 'X' from wpu column of I ² C pins (no wpu available). Added Table 11: Interrupt mapping .

Table 58. Document revision history (continued)

Date	Revision	Changes
10-Jul-2009	8 cont'd	<p><i>Section 10: Electrical characteristics</i>: Added data for TBD values; updated <i>Table 15: Voltage characteristics</i> and <i>Table 18: General operating conditions</i>; updated VCAP specifications in <i>Table 18</i> and in <i>Section 10.3.1: VCAP external capacitor</i>; updated <i>Figure 18</i>; replaced <i>Figure 19</i>; updated <i>Table 35: RAM and hardware registers</i>; updated <i>Figure 22</i> and <i>Figure 35</i>; added <i>Figure 40: Typical application with I²C bus and timing diagram⁽¹⁾</i>. Removed <i>Table 56: Junction temperature range</i>. Added link between ordering information <i>Figure 49</i> and STM8S20xx features <i>Table 2</i>.</p>
13-Apr-2010	9	<p>Document status changed from “preliminary data” to “datasheet”. <i>Table 2: STM8S20xxx performance line features</i>: high sink I/O for STM8S207C8 is 16 (not 13). <i>Table 3: Peripheral clock gating bit assignments in CLK_PCKENR1/2 registers</i>: updated bit positions for TIM2 and TIM3. <i>Figure 5: LQFP 48-pin pinout</i>: added CAN_TX and CAN_RX to pins 35 and 36; noted that these pins are available only in STM8S208xx devices. <i>Figure 7: LQFP 32-pin pinout</i>: replaced uart2 with uart3. <i>Table 6: Pin description</i>: added footnotes concerning beCAN availability and UART1_RX and UART3_RX pins. <i>Table 13: Option byte description</i>: added description of STM8L bootloader option bytes to the option byte description table. Added <i>Section 9: Unique ID</i> (and listed this attribute in <i>Features</i>). <i>Section 10.3: Operating conditions</i>: added introductory text. <i>Table 18: General operating conditions</i>: replaced “C_{EXT}” with “VCAP” and added data for ESR and ESL; removed “low power dissipation” condition for T_A. <i>Table 26: Total current consumption in halt mode at V_{DD} = 5 V, T_A -40 to 85 °C</i>: replaced max value of I_{DD(H)} at 85 °C from 30 μA to 35 μA for the condition “Flash in powerdown mode, HSI clock after wakeup”. <i>Table 33: HSI oscillator characteristics</i>: updated the ACC_{HSI} factory calibrated values. <i>Functional EMS (electromagnetic susceptibility)</i> and <i>Table 47</i>: replaced “IEC 1000” with “IEC 61000”. <i>Electromagnetic interference (EMI)</i> and <i>Table 48</i>: replaced “SAE J1752/3” with “IEC 61967-2”. <i>Table 57: Thermal characteristics</i>: changed the thermal resistance junction-ambient value of LQFP32 (7x7 mm) from 59 °C/W to 60 °C/W.</p>

Please Read Carefully:

Information in this document is provided solely in connection with ST products. STMicroelectronics NV and its subsidiaries ("ST") reserve the right to make changes, corrections, modifications or improvements, to this document, and the products and services described herein at any time, without notice.

All ST products are sold pursuant to ST's terms and conditions of sale.

Purchasers are solely responsible for the choice, selection and use of the ST products and services described herein, and ST assumes no liability whatsoever relating to the choice, selection or use of the ST products and services described herein.

No license, express or implied, by estoppel or otherwise, to any intellectual property rights is granted under this document. If any part of this document refers to any third party products or services it shall not be deemed a license grant by ST for the use of such third party products or services, or any intellectual property contained therein or considered as a warranty covering the use in any manner whatsoever of such third party products or services or any intellectual property contained therein.

UNLESS OTHERWISE SET FORTH IN ST'S TERMS AND CONDITIONS OF SALE ST DISCLAIMS ANY EXPRESS OR IMPLIED WARRANTY WITH RESPECT TO THE USE AND/OR SALE OF ST PRODUCTS INCLUDING WITHOUT LIMITATION IMPLIED WARRANTIES OF MERCHANTABILITY, FITNESS FOR A PARTICULAR PURPOSE (AND THEIR EQUIVALENTS UNDER THE LAWS OF ANY JURISDICTION), OR INFRINGEMENT OF ANY PATENT, COPYRIGHT OR OTHER INTELLECTUAL PROPERTY RIGHT.

UNLESS EXPRESSLY APPROVED IN WRITING BY AN AUTHORIZED ST REPRESENTATIVE, ST PRODUCTS ARE NOT RECOMMENDED, AUTHORIZED OR WARRANTED FOR USE IN MILITARY, AIR CRAFT, SPACE, LIFE SAVING, OR LIFE SUSTAINING APPLICATIONS, NOR IN PRODUCTS OR SYSTEMS WHERE FAILURE OR MALFUNCTION MAY RESULT IN PERSONAL INJURY, DEATH, OR SEVERE PROPERTY OR ENVIRONMENTAL DAMAGE. ST PRODUCTS WHICH ARE NOT SPECIFIED AS "AUTOMOTIVE GRADE" MAY ONLY BE USED IN AUTOMOTIVE APPLICATIONS AT USER'S OWN RISK.

Resale of ST products with provisions different from the statements and/or technical features set forth in this document shall immediately void any warranty granted by ST for the ST product or service described herein and shall not create or extend in any manner whatsoever, any liability of ST.

ST and the ST logo are trademarks or registered trademarks of ST in various countries.

Information in this document supersedes and replaces all information previously supplied.

The ST logo is a registered trademark of STMicroelectronics. All other names are the property of their respective owners.

© 2010 STMicroelectronics - All rights reserved

STMicroelectronics group of companies

Australia - Belgium - Brazil - Canada - China - Czech Republic - Finland - France - Germany - Hong Kong - India - Israel - Italy - Japan - Malaysia - Malta - Morocco - Philippines - Singapore - Spain - Sweden - Switzerland - United Kingdom - United States of America

www.st.com

